

Demand Management Strategy

December 2019



This is the Demand management strategy technical supporting report.

This document describes the Demand Management Strategy of Anglian Water and is a Supplementary Technical document to our Water Resources Management Plan (WRMP) 2019 submission. It covers the period from 2020 to 2045.

It describes our demand management strategy; the options we have included; their appraisal and our comprehensive cost benefit analysis. It explains our methodology and the detailed results of our analysis of demand management.

- All data, tables and figures reflect the 2017/18 baseline.

We have collaborated and engaged extensively in the development of our WRMP. We feel that this is of particular importance due to material water resource challenges we face in our supply area.

1.1 The Water Resources Management Plan

Our WRMP submission is comprised of several reports, as set out in the diagram below. The main submission is supported by technical documents that explain our methodologies and provide the detailed results of our analysis.

Figure 1.1 WRMP 2019

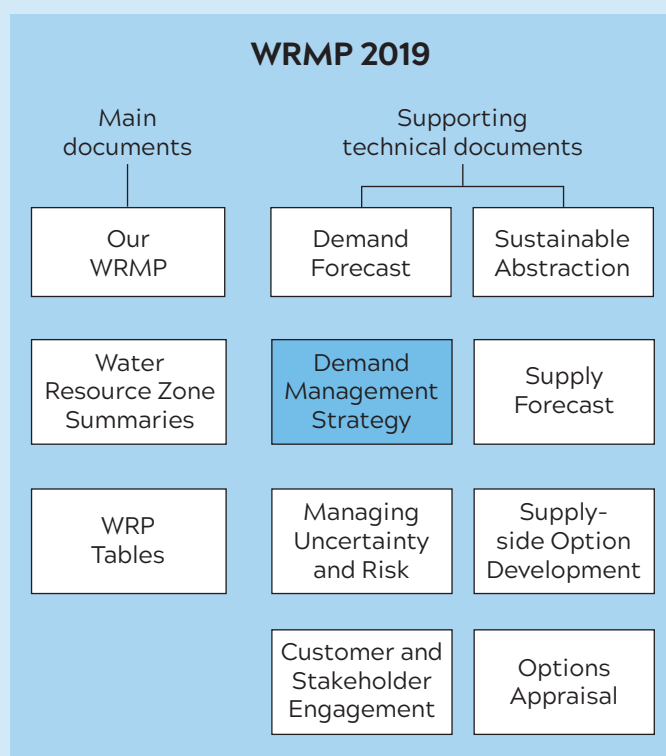

Contents

1. Executive Summary	5
2. Introduction	7
3. Strategic need	9
This section describes the issues that demand management strategies will address	
3.1 Government policy and regulatory guidance	10
3.2 Population and demand growth	12
3.3 Sustainability, climate change and drought resilience	14
4. Customer Expectations	15
This section describes evidence indicating why customers prefer demand management; the functionality that smart metering could provide, including support for leakage reduction and support for additional water efficiency measures.	
4.1 A collaborative plan	16
4.2 Regional and national stakeholder collaboration - Water Resources East (WRE)	16
4.3 Formal WRMP 2019 pre-consultation	17
4.4 The customer view	18
4.5 Conclusions	20
5. Our Preferred Plan	21
This section describes our preferred plan; how additional smart meter functionality will be used to deliver benefits and meet customer need; how smart metering will be delivered across the AWS region; how additional leakage reductions will be implemented; who will be targeted by our enhanced water efficiency programmes. It will also describe the approach to procurement; how the smart metering and other programme will be procured (in-source /out-source etc.);	
5.1 Our preferred plan and the deployment of demand management options	22
5.2 Data, smart metering and customer usage	28
5.3 Leakage Reduction	41
5.4 Water Efficiency	44
6. Options Considered (and rationale for selection)	47
The method for evaluating alternative options; option scale; roll-out and timing; geographic and demographic targeting. The explanation of the holistic approach taken.	
6.1 Developing the option list	47
6.2 Screening the unconstrained list	48
6.3 Developing strategic options	48
6.4 The strategic options	50
6.5 Tariff and price signals	67
6.6 Compulsory dumb metering	67
6.7 Price Incentives	67
6.8 Demand and the price of water	68
6.9 Water tariffs	69
6.10 Other tariffs	71

7. Costs and benefits

74

A consolidated overview of expenditure and benefits setting out key assumptions.

7.1 Our approach	74
7.2 Sources of evidence and assumptions	75
7.3 Cost and benefit building blocks	75
7.4 CBA Modelling	75
7.5 Benefits	75
7.6 Value of deferred supply-side capital investment	75
7.7 Notes on the derivation of deferred supply-side capital investment values	77
7.8 Demand management options and carbon emissions	78
7.9 Qualitative benefits	80
7.10 Outputs	80
7.11 Benefit categories	81
7.12 Cost categories	82
7.13 Leakage Costs, building blocks and assumptions	83
7.14 Leakage Benefits	84
7.15 Metering costs and benefits	85
7.16 Metering quantitative benefits	86
7.17 Metering qualitative benefits	89
7.18 Metering Scenarios and costs	90
7.19 Water efficiency costs and water savings	91
7.20 Water efficiency building blocks, assumptions and benefits	94
7.21 Societal valuation	95
7.22 Using the societal valuations	96
7.23 Option 1 - Extended - Cost-benefit analysis	97
7.24 Option 2 - Extended Plus (preferred) - Cost-benefit analysis	98
7.25 Option 3 - Aspirational - Cost-benefit analysis	100

8. Risks and issues

101

Describes the underlying assumptions that, if changed, would impact the case; explanation of our understanding of uncertainties.

8.1 Anticipated risks and issues	101
8.2 Scenario testing	103
8.3 Monitoring programmes, 'trigger points' and adaptive planning	104
8.4 Risk mitigation	104
8.5 Smart metering and wider UK experience	105

Appendix 1

107

1. Executive Summary

The challenge

It is anticipated that demand will increase by over 109 MI/d over the WRMP plan period, due to the effects of growth, from an additional 1 million customers.

Our track record and commitment

However, we have an enviable historical track record in mitigating demand.

We now put less water into the supply system than in 1989, despite an increase of more than 30% in the households we serve.

Our leakage performance is industry leading, currently representing 16.7% of our total demand.

In the current year 2017/18, we have over 89% of household properties with installed meters and 81% of customers paying measured charges.

Developing our strategy

Given the scale of the challenges, we have collaborated extensively in the development of our WRMP, utilising our extensive customer engagement programme to ensure that our customers fully understand demand related issues.

Generally, customers prefer options that are perceived to make best use of existing resource and infrastructure. Leakage continues to be a priority and an emblematic issue.

We understand that our strategy must underpin regional planned economic and housing growth in a sustainable manner.

We have also been committed to establishing Water Resources East, a leading example of collaborative, multi-sector planning, working with partners to develop a long-term strategy for water stewardship in the East of England, which stresses significant demand management intervention.

We have sought to develop our demand management plan using a holistic approach, utilising new technologies such as 'smart metering' and the potential of the abundance of data this would make available, to help both ourselves and our customers understand water usage, drive down leakage and influence future behaviour.

This information revolution, will allow both Anglian Water and our customers to embark on a new journey, with a step change in the possibilities of interaction.

Our preferred plan

We intend to build on these past successes and have developed an ambitious, integrated, cost beneficial demand management strategy that will more than offset the effects of growth.

Using new technology and innovation, our strategy will unlock estimated demand savings of up to 43 MI/d by the end of AMP7 (2025), and 123 MI/d by the end of the planning period (2045).

The cost of our demand management strategy is £255 million (totex) in AMP7 (2020-2025). This does not result in an impact on the average customer bill as the costs are offset by the additional revenue from new connections (assuming that forecast growth materialises). We have undertaken an assessment of costs and benefits which shows that our strategy is cost beneficial.

This ambitious strategy will comprise three strongly interlinked programmes, as described (This has been termed our 'Extended Plus' Option). These will combine to deliver the significant demand savings we plan to achieve over the WRMP period.

Figure 1.1: Our holistic plan

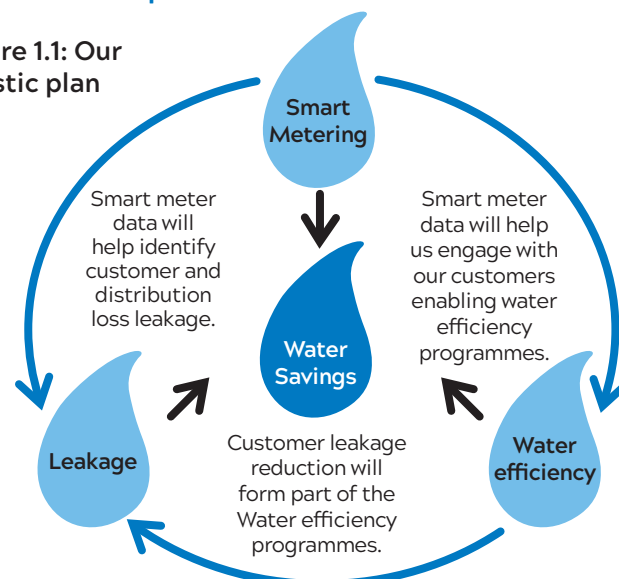

Our ‘Extended Plus’ option allows us to innovate and deliver a step change in our demand management activity, while delivering a strong economic case. It will include:

- A smart metering programme, with the key aim of significantly increasing consumption data for our customers and ourselves. Smart meter installation, will enable a step change in customer communications, allowing more effective behavioural change programmes and consequent reductions in demand. Additionally, smart meters will significantly enhance our ability to detect and react to leaks in customer properties. We plan to reach the limit of feasible meter penetration (95%) by 2030 (all smart). This will result in demand savings from changes in customer behaviour of up to 9 MI/d by 2030, and up to 24 MI/d by 2045.
- Leakage reduction of 22% from the 2017/18 baseline (40 MI/d) by 2025. We will then continue to reduce our leakage to 106 MI/d by 2045, which represents a 42% reduction in total from our current baseline. This includes the savings in customer supply pipe leakage (cspl) that will be facilitated by smart meters. Leakage will reduce from the current level of 16.7% of distribution input (DI) to less than 10% of DI by 2045.
- Additional water efficiency activities that together will result in demand savings of up to 9 MI/d by the end of AMP7 and 30 MI/d by 2045. By the end of the period (2045), we expect that our average per capita consumption (PCC) will be 120 litres/head/day, a reduction of 12% (17 litres/head/day) compared with 2017/18 regional average of 136 litres/head/day.

Figure 1.2: The impact of our demand management strategy on average per capita consumption (PCC)

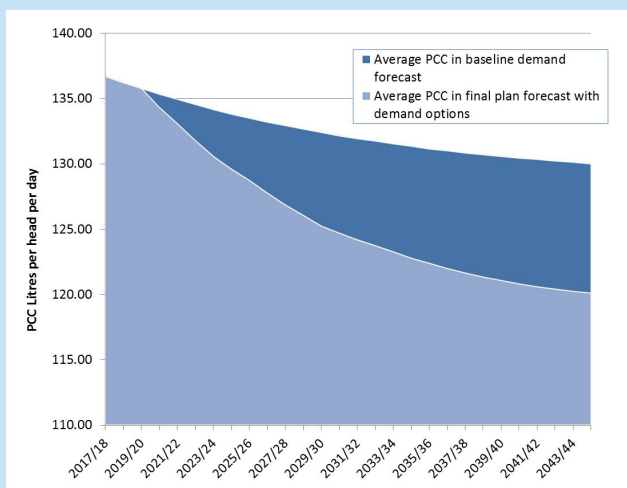

As can be seen, in totality, in our preferred option package, the demand management programmes should effectively mitigate the growth impact from demand.

Figure 1.3: Demand reductions from our preferred strategy compared to forecast growth

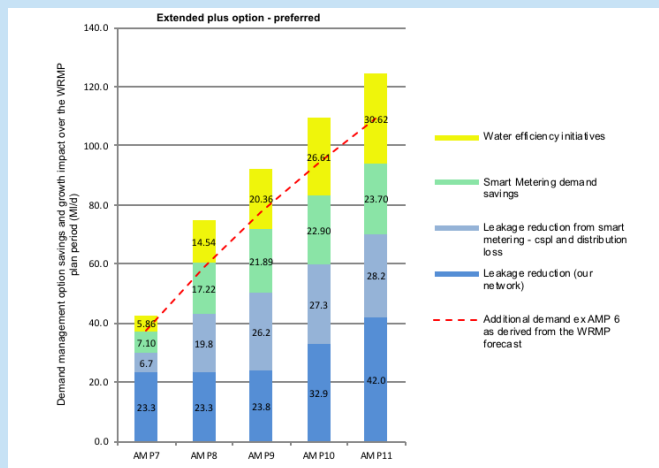

Without demand management consumption (DYAA) is forecast to rise by 109 MI/d over the WRMP period.

However, with our preferred ‘Extended Plus’ management option this is completely mitigated with consumption in 2045 set to decrease by 18MI/d from the initial 2020 value (1130 MI/d).

Figure 1.4: Consumption with and without the ‘Enhanced Plus’ demand management strategy

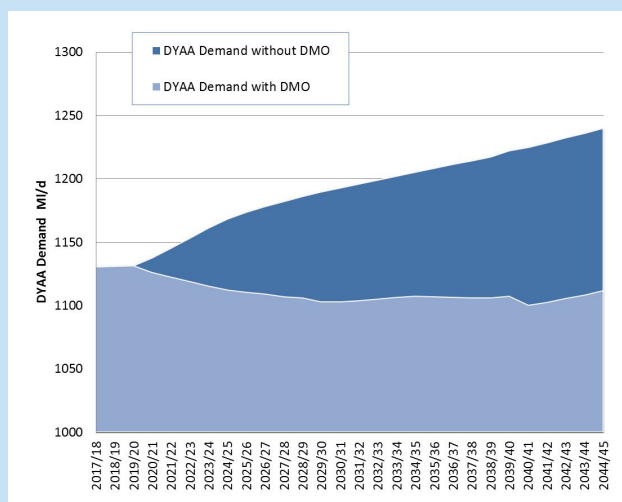

‘Extended Plus’ will form part of our ambitious and deliverable twin track approach, of using demand and supply solutions, to secure future water supplies.

2. Introduction



About us

- We are the largest water and waste water company in England and Wales by geographic area. Every day, we supply over 1 billion litres of water into over 2 million households and 5 million people in the East of England and Hartlepool.
- The characteristics of our region mean that we face major challenges from climate change, sustainability, resilience and environmental protection, which are particularly acute.
- The East of England is comparatively dry, receiving approximately 600mm of rainfall per year, and is designated by the Environment Agency as an area of serious water stress. It is also environmentally sensitive and home to many internationally important wetland ecosystems that need protection.
- Our region has the highest rate of population growth outside of London. Population is predicted to rise by over 1M by 2045.
- Our strategy must underpin the planned economic and housing growth in a sustainable manner.
- We have proven our ability to manage demand for water supplies: we put less water into our network today than we did in 1989, even though the number of properties supplied has increased by over 30%.
- By the end of AMP6 our meter penetration is forecast to be at 91% with a meter installed and 85% paying by a measured bill. By the end of AMP7 we forecast that we will have installed 95% of our customers with a meter and 90% will be paying measured bills (The difference is due to our Enhanced metering programme).
- Our leakage in 2017/18 was 182.66 Ml/d, significantly below our previous sustainable economic leakage level (SELL) of 211Ml/d and close to our current 3 year rolling average target of 177Ml/d.
- We have set ourselves ambitious goals to reduce our carbon emissions over AMP7 (2015-20), and have already made great progress towards them. In 2016-17 we reported an 11% reduction in operational carbon (from a 2015 baseline) and a 55% reduction in capital carbon (from a 2010 baseline). We now plan to become net zero carbon by 2030.

Overview

Ensuring we have sufficient water resources available to provide secure and clean supplies of water to our customers, is key to our success.

Understanding and managing demand for water is crucial to maintaining the balance between supply and demand and has motivated this development of an integrated long-term demand management strategy.

This demand management strategy document:

- Identifies options and our appraisal methods for determining how we can more effectively manage demand for water.
- Describes the results of our engagement with customers and key stakeholders.
- Describes how we have appraised the potential options.
- Presents the results of our analysis, both quantitative and qualitative, and,
- Outlines how our selected optimised demand management package will be implemented over the next 25 years.

We have structured the document into the sections described below.

• Strategic need

- Provides context regarding the challenges we face and why we think demand management is an important tool to meet these challenges.

• Customer support

- Summarises our approach to customer engagement, evidencing views on the strategy from our conversations with customers and key stakeholders.

• Our Preferred Plan - Deployment options

- Identifies our chosen package of demand management activities for the WRMP 25 year plan and explains the reasoning behind our decision.

- Describes how the demand management options will be implemented and how they will deliver benefits and meet customer need.
- Outlines our approach to delivery and progress monitoring.
- **Options considered and the rationale for selection**
 - Outlines how we have evaluated and selected the options for managing demand.
 - Describes the options we have considered but not pursued.
 - Presents the results of our analysis and the rationale behind the strategic package of options we have finally proposed.
- **Costs and benefits**
 - Consolidated overview of expenditure and benefits; setting out key assumptions.
- **Risks**
 - Discusses the underlying assumptions, uncertainties and identifies key sensitivities that if changed would impact the plan.

Note that some of these Sections include subdivisions reflecting the three major strands of demand management included in the plan:

- **Water metering Strategies.**
- **Leakage reduction**
- **Water efficiency**

The overall structure, however, reflects the integrated holistic nature of our preferred plan and the synergies between each element:

2.1 Our approach

Our approach to demand management is fully aligned with our corporate vision:

‘Water is our business. We handle it with care and we don’t cost the earth’.

This vision is embodied in our ‘Love Every Drop’ strategy, placing water at the heart of a whole new way of living.

Bearing this in mind, we believe that managing demand for water should be considered the right choice for us, our customers and the environment.

Additionally, demand management can represent a selection of ‘low regret’ investment options, allowing more time to be available to make the most informed decisions on whether large supply side investments are required.

Customers strongly support some demand management activities (such as fixing leaks) and reflecting this, since privatisation we have focused on managing demand for water and have proven our ability to do this. We put less water into our system now than we did in 1989 despite supplying 30% more people in the Anglian Water region.

Figure 2.1: Water supplied and leakage since 1998 to the present

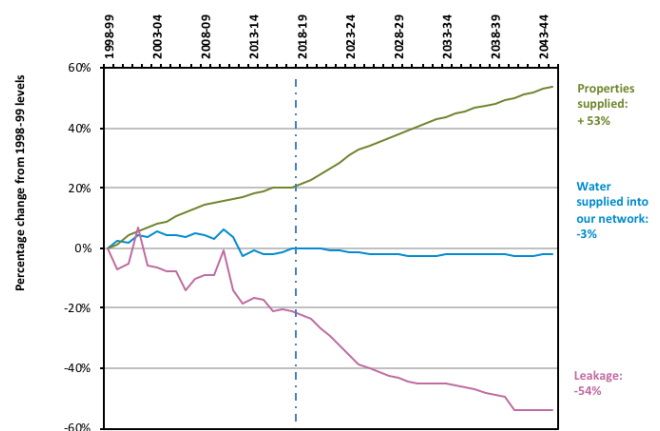

Thus our approach to managing the demands on water has been focused upon three broad groups of activities:

Water metering Strategies - how the data resulting from ‘smart metering’ can help with detecting leakage and can assist in influencing customer usage,

Leakage reduction - how we might innovatively target both losses in our distribution system and losses due to customer supply pipe leakage, and,

Water efficiency measures - how new technologies and our activities can help promote the careful use of water by both our household and non-household customers.

3. Strategic need



Overview

Water resources in our region are expected to suffer significant pressures from increasing demand due to population growth, climate change, sustainability reductions and the need to increase our resilience to severe drought.

In particular the population is forecast to increase by 1M over the WRMP period, implying a potential increase in water demand of 109Ml/d (DYAA forecast). The assessment of growth in the region has been driven by our understanding of Local Authority Planning information and we have been keen to ensure that our strategy supports local growth and is carried forward in consultation with Local stakeholders.

These challenges are acute and they drive the need for investment on both demand management and supply-side options, particularly in the short and medium-term. Consequently, our region has been classified by the Environment Agency as an area of serious water stress.

To ensure we can provide our customers with clean, safe water we consider the widest range of options to secure our water supplies, using a 'twin track' approach, exploring options to increase our capacity to supply water, as well as options to reduce demand. By exploring both supply and demand options we can ensure a cost effective, secure supply-demand balance, whilst ensuring the environment is protected.

In particular, in developing our WRMP, we have noted the stress placed upon demand management by Defra, as a preferred strategy to address anticipated growth and mitigate environmental impact.

We have taken special account of the Guiding Principles;

*'We expect you to choose demand-side options as part of the preferred programme wherever it is reasonably likely that the benefits will outweigh the costs.'*¹

and that;

*'WRMPs are expected to continue to ensure the reduction of the overall demand for water through demand management activities; including the reduction of leakage and increasing water efficiency through metering programmes.'*²

Additionally, we have noted that it is expected that leakage should remain a priority and that, between 2020 and 2025, companies should aim to achieve at least a 15% reduction in leakage.

This guidance has, consequently, been key to informing and developing our demand management strategy.

¹ Defra, May 2017, *Guiding principles for water resources planning*, Page 6

² Defra, May 2017, *Guiding principles for water resources planning*, Page 2

3.1 Government policy and regulatory guidance

3.1.1 Defra's guiding principles

The key policy priorities that the government expects WRMPs to address are set out in Defra's Guiding Principles for Water Resources Planning, published in May 2016.

Government objectives include:

- To deliver secure, reliable, sustainable and affordable supplies of water
- Value nature in decision-making, and
- Connect people with the environment.

We have highlighted particular themes within the Guiding Principles that our demand management strategy addresses below.

'Take a long term, strategic approach to protecting and enhancing resilient water supplies'

WRMPs should represent 'best value' to customers over the long-term, and companies are encouraged to consider a planning horizon that goes beyond the 25 year minimum.

Defra emphasises the importance of resilience, stating:

'We want to see a real change in approach to your WRMP so that it properly examines the value of resilience for your customers, is informed by your customers' views and identifies what actions you will take to reduce risk now and in the future. This is particularly important where you identify there is a greater risk of supply interruptions than your customers expect.'³ This includes the consideration of an appropriate Level of Service that is informed by 'meaningful customer engagement', the potential impacts of restrictions on households and businesses, and more thorough testing of water supply systems to events more severe than those contained within the historic record.'⁴

Consequently, in the development of the WRMP, we have sought to develop an integrated, multi-AMP supply and demand management strategy. This strategic approach to managing demand will allow us to best optimise our long term planning, and support resilient water supplies by offsetting demand growth.

'Consider every option to meet future public water supply needs'

In order to determine the 'best value' solution for customers, companies must fully consider every potential option, including those outside of company boundaries, collaborating with other sectors, inter-company transfers, trading, and demand management.

Companies are expected to thoroughly investigate and report on the environmental and social costs and benefits associated with options, including carbon costing, the value of natural assets, and customer support.

In order to satisfy this requirement a thorough programme of option appraisal and selection has been conducted. (This will be described in detail in the chapter: Options considered (and the rationale for selection))

'Protect and enhance our environment, acting collaboratively'

The Guiding Principles emphasise the important role that water companies play as 'leaders' and 'stewards' of the natural environment. As such, companies are expected to contribute towards the delivery of a healthier water environment, more resilient to drought and pollution that offers economic and social benefits.'⁵

As stated above, companies are expected to thoroughly investigate environmental and social costs and benefits, in order to make informed decisions that reflect the value of the environment.

Acting collaboratively with customers and other stakeholders is at the core of our demand management options.

Demand management will protect the environment by reducing the need for disruptive supply side interventions and keeping water in the environment longer.

'Promote efficient water use and reduce leakage'

WRMPs are expected to continue to ensure the reduction of the overall demand for water through demand management activities; including the reduction of leakage and increasing water efficiency through metering programmes (although compulsory metering is not seen as the right way forward), especially for companies in a designated

³ Defra, May 2017, Guiding principles for water resources planning, Page 2

⁴ Defra, May 2017, Guiding principles for water resources planning, Page 2

⁵ Defra, May 2017, Guiding principles for water resources planning, Page 4

area of serious water stress. Companies are expected to continue to reduce leakage.

The Guiding Principles state: ‘We expect you to choose demand-side options as part of the preferred programme wherever it is reasonably likely that the benefits will outweigh the costs.’⁶

We strongly believe in the promotion of efficient water use and have demonstrated a strong track record in reducing leakage, which we are keen to continue.

Our demand management strategy will seek to go further, setting ambitious goals for leakage, increasing the penetration of metering and introducing new technologies. We intend to remain a leading company in this area.

3.1.2 Ofwat’s PR19 methodology

In December 2017 Ofwat published its methodology⁷ for the next price review, known as PR19. This details Ofwat’s expectations for company business plans for the next AMP; what should be considered and how the plans will be assessed.

The final methodology makes it clear that Ofwat continues to expect companies should develop strategies for additional demand management savings.

The methodology also includes mechanisms that aim to promote the use of water trading and demand management strategies, through the establishment of new markets.

Leakage guidance

The methodology makes clear that Ofwat expects companies to continue to drive reductions in leakage.

Between 2020 and 2025 companies will need to achieve either:

- *At least a 15% reduction in leakage*

or:

- *More than the largest leakage reduction achieved in the 2015 to 2020 period by any company.*⁸

Companies that are not committing to meet these targets will need to robustly justify why they should not apply them.

When developing plans and targets, Ofwat expects that companies⁹

- *‘Take account of the view of their customers, local stakeholders and CCGs*
- *Relate leakage to the overall water resource management plan (WRMP)*
- *Relate to their SELL, including the upper and lower limits*
- *Take into account the future value of water, water trading and resilience*
- *Take into account the additional benefit that reducing leakage can have in encouraging customers to reduce their water usage, and,*
- *Take into account expected improvements and innovations in the efficiency of reducing leakage.’*

Whilst developing our WRMP and demand management strategy, we have been mindful of all the items described in Ofwat’s guidance.

We have done this by taking a holistic approach and integrating our demand management activities within the broader context of our WRMP, engaging extensively with customers and considering the wider benefits of reducing leakage.

Additionally, we have been instrumental in establishing and continue to drive the Water Resources East (WRE) initiative. WRE aims to develop a multi-company, multi-sector approach to managing water resources in the East of England.

Saving water - water efficiency guidance

The methodology proposes that there should be a common performance commitment for companies on per capita consumption (PCC)¹⁰

Monitoring per capita consumption for both measured and unmeasured customers (and non-household customers) will provide the baseline for assessing the effectiveness of interventions aimed at changing customer behaviour and reducing individual usage.

³ Defra, May 2017, Guiding principles for water resources planning, Page 2

⁴ Defra, May 2017, Guiding principles for water resources planning, Page 2

⁵ Defra, May 2017, Guiding principles for water resources planning, Page 4

⁶ Defra, May 2017, Guiding principles for water resources planning, Page 6

⁷ <https://www.ofwat.gov.uk/regulated-companies/price-review/2019-price-review-final-methodology/>

⁸ Ofwat, July 2017, Delivering Water 2020: Our final methodology for the 2019 price review, Page 5

⁹ Ofwat, July 2017, Delivering Water 2020: Our final methodology for the 2019 price review, Page 55

¹⁰ Ofwat, July 2017, Delivering Water 2020: Our final methodology for the 2019 price review, Page 54

This performance commitment will drive further water efficiency measures and in particular will motivate a commitment to increase meter penetration and the introduction of new metering technologies

These new metering technologies will allow much greater customer engagement and interaction, enabling a far greater understanding of water usage and behaviour, and, potentially, enabling a change of mind-set with regard to water efficiency going forward.

3.2 Population and demand growth

The Anglian water region is forecast to experience significant growth over the planning period (2020-2045) in terms of both properties and more importantly for population (which drives demand).

Growth forecasts have been derived using Local Authority Planning information (for all 65 Local Authorities in our region) and indicate that:

- Baseline Household Population 4.542M (2017/18)
- Baseline Properties 2.033M (2017/18 - including voids)
- Population is forecast to increase by 1.03M from 4.619M (2019/20) to 5.650M (2044/45), during the WRMP 2019 planning period.
- Note population is forecast to increase by 22% over the plan period, reflecting official ONS reducing occupancy rates)
- Households are forecast to increase by 573,000 from 2.079M (2019/20) to 2.653M (2044/45), during the WRMP 2019 planning period
- Households are forecast to increase by 28% over the plan period, reflecting LAUA planning data
- Note there is an additional allowance for communal-non-household population (currently estimated at 63K). The consumption for this is accounted for in the Non-Household forecast.

This planned growth has been analysed at a sub-regional level, indicating where high levels of growth and 'hot-spots' are expected at resource zone and sub-resource zone level.

Figure 3.1: Relative % population growth - Resource Zone (WRZ) (Red = largest % change 2020-2045 - Note the colour grading is relative to this map only)

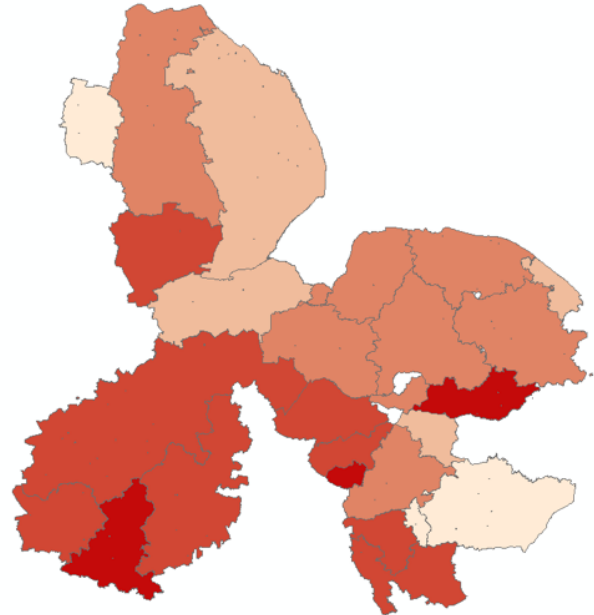

Growth 'hotspots' have been identified in;

- Central Lincolnshire WRZ (Lincoln),
- Ruthamford North WRZ (Corby, Wellingborough, Daventry, Peterborough),
- Ruthamford Central WRZ (Newport Pagnell, Milton Keynes)
- Newmarket WRZ (Newmarket)
- South Essex WRZ (Colchester, Braintree)

Figure 3.2: Relative % population growth - 'Hot-spots' - (Red = largest % change 2020-2045 - Note the colour grading is relative to this map only) - (shown in Demand Zones)

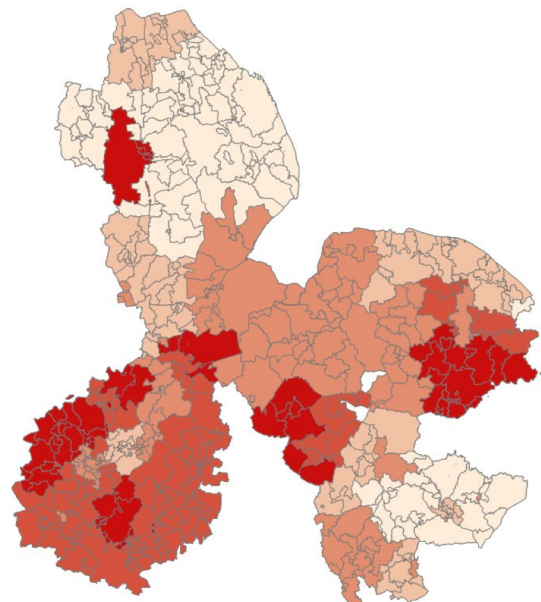

These levels of growth will have a direct impact on the amount of water required for distribution input, in order to supply this growing population.

Unrestricted consumption is projected to increase by 105MI/d over the planning period (2020-2045) (NYAA forecast), rising from 113MI/d (2020) to 1218 (2045).

For the Dry Year Annual Average scenario, unrestricted consumption is projected to increase by 109 MI/d over the planning period (2020-2045) (DYAA forecast), rising from 1130MI/d (2020) to 1239 (2045).

This increase is wholly driven by the increase in forecast population, whilst including baseline water efficiency measures and accounting for changes in measured / unmeasured status.

Figure 3.3: Regional forecast demand without demand management options

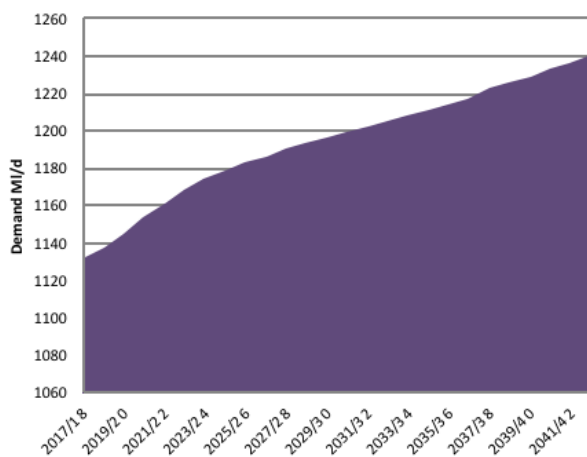

In detail this may be broken down to the main consumption elements;

Figure 3.4: Forecast demand without demand management options

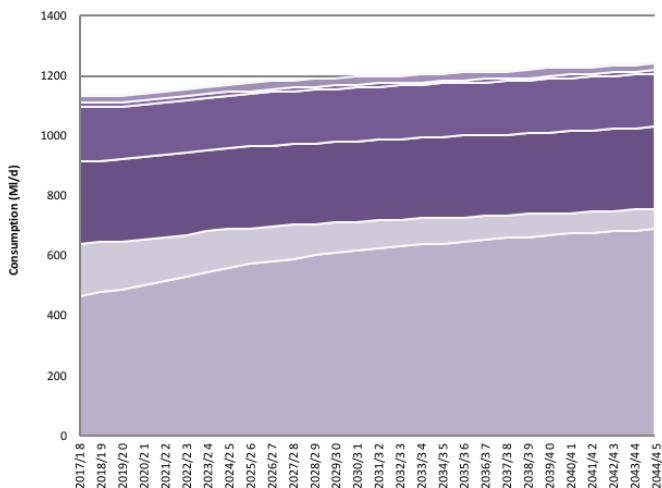

Unrestricted growth in demand has been analysed at the WRZ geographic level and can be shown:

Figure 3.5: Forecast demand without demand management options

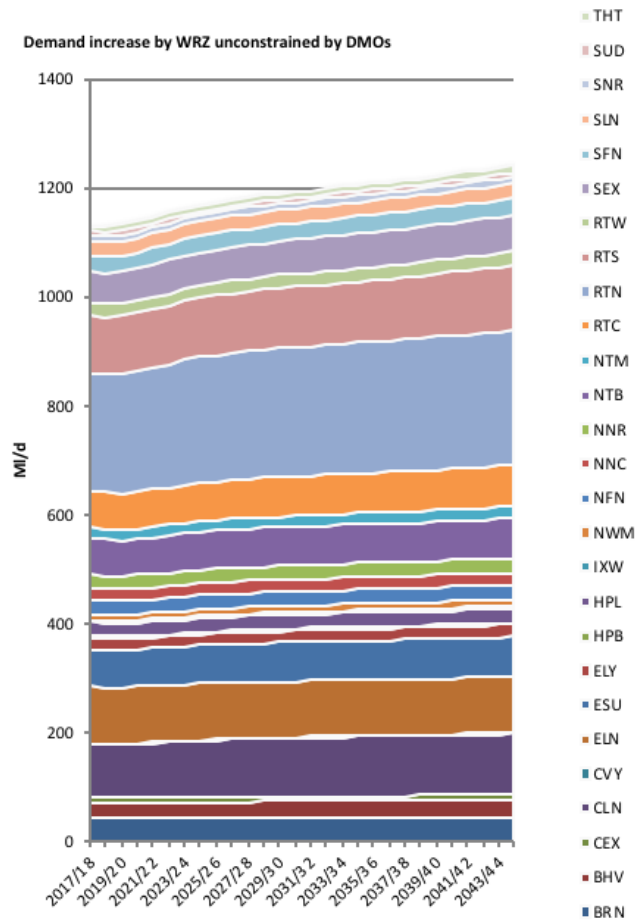

Thus the impact of growth in demand can be shown at the WRZ level, reflecting both the relative size and changes in population and changes in non-household demand.

Figure 3.6: Impact of growth on demand 2020-2045, in MI/d.

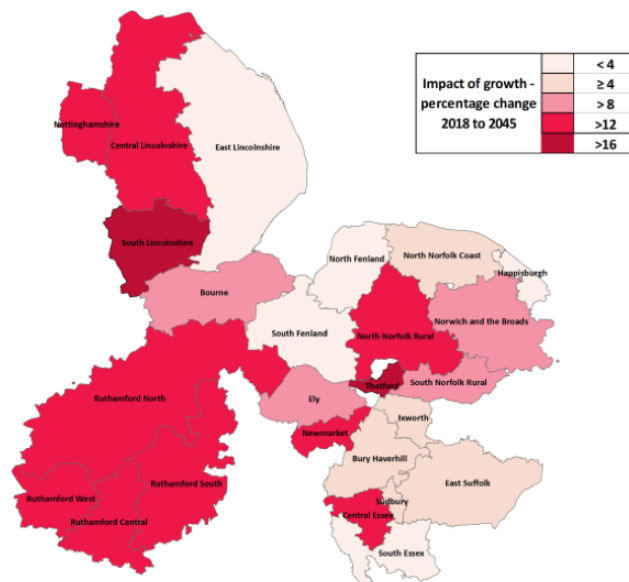

3.3 Sustainability, climate change and drought resilience

In addition to the impact on demand from population growth, significant changes and reductions are anticipated with regard to water availability (in order to maintain sustainable supplies for the foreseeable future). These changes will have a significant impact in the way we maintain the supply of water to match forecast increases in demand; the supply-demand balance.

Figure 3.7: Baseline supply-demand balance in 2045 (Principal Planning Scenario DYAA)

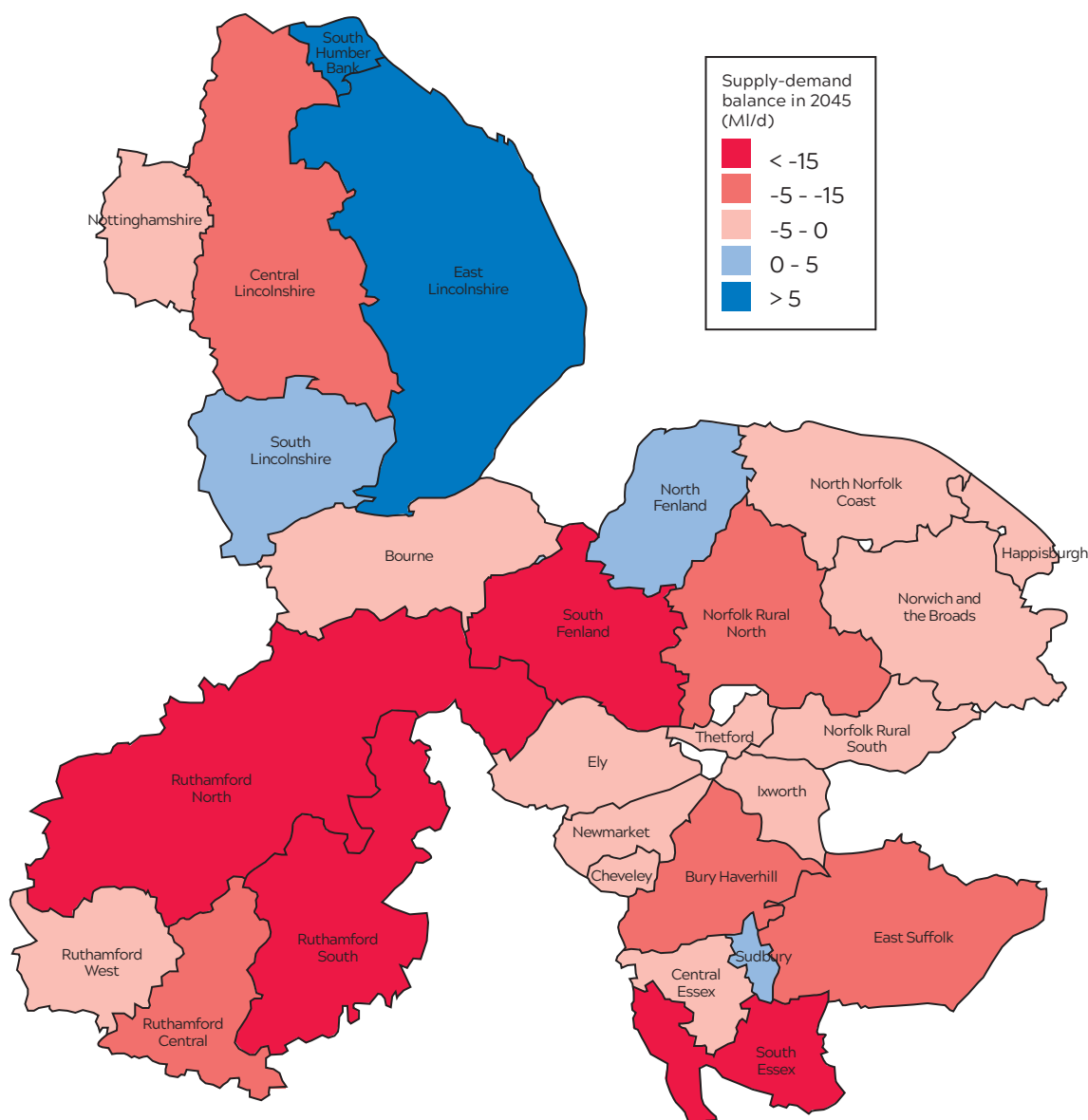

Thus, our demand management strategy has been designed to counteract the increase in demand due to growth across our region, over the WRMP plan period (109MI/d).

4. Customer Expectations

Given the scale of the challenges that we anticipate, we have actively collaborated and engaged extensively during the development of our WRMP.

Additionally the Water Resources East (WRE) project has enabled collaboration with major stakeholders in our region.

Our conversations with customers and stakeholders

Customer engagement is central to both the daily running of our business and our long-term decision making processes. We continue to refresh our customer engagement strategy and embed it as a business as usual activity.

Our new strategy places greater emphasis on ensuring our engagement is meaningful to customers and explores differences of opinion, experience and behaviours between different groups of customers.

To date, over 45,000 customers have been involved in a range of initiatives including:

- Targeted deliberative research via our 'Love Every Drop' online community
- The Anglian Water tour bus and the H2OMG water festival, and
- Research to segment customers attitudinally and societal valuation surveys.

We have also undertaken extensive work to understand the value that customers place on certain standards of service and different outcomes. We have used the outputs of these studies in our cost benefit analysis.

Key conclusions include:

Customers are fully supportive of our 'core' responsibility in ensuring that supply meets demand.

Customers support investment to increase resilience and believe we should be planning for the long-term and taking preventative action to deal with foreseeable future challenges.

Generally, customers prefer options that are perceived to make best use of existing resource and infrastructure. However, many customers also recognise our expertise and trust us to make complex investment decisions.

Leakage continues to be a priority and an emblematic issue.

Although customers are prepared to accept bill increases for service improvements that they value, many customers are feeling under financial pressure and are concerned about future bill increases.

4.1 A collaborative plan

We believe customer engagement must be at the heart of all that we do as a company, not just for set piece consultations. We have therefore embedded it as a core ‘business as usual’ activity. Our on-going programme of customer engagement is extensive, robust and innovative.

We have built upon the extensive engagement undertaken for the PR14 business plan.

In the autumn of 2016 we began to refresh our customer engagement strategy and plans.

From the outset we involved customers in the co-creation of our strategy, to ensure that the engagement would be meaningful.

This has helped us to develop our understanding of the world from a ‘customer’s point of view’, and has ensured that we have developed our initiatives, language and materials in a way that would best engage customers in the risks and issues we are facing.

In addition, we have sought to explore differences of opinion, experience and behaviours between different demographic groups of customers.

This is particularly important when considering the potentially different needs and preferences of customers in vulnerable circumstances.

To date, over 45,000 customers have been involved in a range of initiatives that have been designed to;

- Better understand our customer base;
- Reach a large number of customers; and
- To explore more complex issues in depth.

A key focus of this research was water resource, demand management options and resilience to drought.

Specific activities have included the targeted deliberative research via our ‘Love Every Drop’ online community, the Anglian Water tour bus, the H2OMG water festival, research to segment customers attitudinally and societal valuation surveys.

In our draft Problem Characterisation assessment, we identified that there are complex trade-offs involved in determining an appropriate level of demand management activity.

While demand management programmes tend to be prioritised by customers and have direct environmental benefit, these can prove costlier than alternative supply-side solutions and the potential savings can be less certain, particularly for initiatives where there is little or no UK experience.

As a result, our customer engagement activities included a focus on the development of water resources and demand management options. Activities were designed to help us determine an appropriate balance of demand management and supply-side options.

More details on our customer engagement programme and individual initiatives can be found in our WRMP Company Summary Report.

4.2 Regional and national stakeholder collaboration - Water Resources East

The scale of the challenges we face from drought, climate change, population growth and meeting the needs of the environment are common to the South East, impacting neighbouring water companies, as well as to the other abstractors and users of water across the region and adjoining regions.

To ensure that we all have access to reliable, sustainable and affordable water supplies in the future, we are leading a number of collaborative water resource planning efforts.

We helped establish and continue to drive the Water Resources East (WRE) initiative. WRE aims to develop a multi-company, multi-sector approach to managing water resources. WRE brings together partners from a wide range of sectors, including water, energy, retail, the environment, land management and agriculture, to work collaboratively to manage water challenges and pioneer new approaches to planning and managing water resources.

Analysis from WRE suggests that demand management is an essential component of any long-term, sustainable water resource strategy for the region. Were demand to be left to grow unchecked, it would result in widespread deficits and service failures (including rota-cuts and standpipes) by the 2060s.

The WRE option appraisal process shows that a reliable, sustainable and affordable strategy depends upon a combination of demand management and supply-side solutions. The WRE leadership group concluded in December 2017 that uncontrolled growth in demand will drive a catastrophic failure of water resource and supply systems.

We are also actively involved with the:

- Water efficiency strategy steering group and the customer leadership group working with Waterwise in both groups
- Water UK Water Resources Long-Term Planning Framework (WRLTPF) and,
- Trent and Ouse Working Groups.

We have also participated in Water Resources South East (WRSE) and have had regard to their project outputs in the development of our WRMP.

While the Water UK WRLTPF and the WRSE projects consider public water supply issues only, WRE and the Trent and Ouse Working Groups consider multi-sector needs. The continuing purpose of these collaborations is to develop a common understanding of water resource planning issues and to identify cost-effective options for sharing available resources, including transfers and trading.

Partners in our different collaborations include representatives from agriculture, drainage, power, environment, local government, business and finance sectors, other water companies, Defra, Ofwat, the Environment Agency and Natural England.

4.3 Formal WRMP 2019 pre-consultation

Through the formal pre-consultation process, we have engaged with regulators, water companies and retailers, local authorities, environmental and conservation groups and catchment partnerships. Our pre-consultation communication was sent to over 150 key stakeholders outlining the issues we face, and how to participate in the consultation of our WRMP.

We worked closely with the Environment Agency via an agreed methods discussion process, holding many meetings between May 2016 and November 2017, in order to develop our technical approach and plan.

We also engaged with Ofwat (holding a WRMP Master class in December 2016, a formal pre-consultation meeting in August 2017, and follow-up communications) and Natural England (as part of the Strategic Environmental Assessment and Habitats Regulation Assessment processes).

Some of our responses may be summarised:

Bedfordshire County Council:

'AWS is right to prioritise demand management.'

Buckinghamshire County Council:

'The demand management strategy... should be a key priority going forward. The introduction of smart metering is a good way forward in this area.'

Central Bedfordshire Council:

'Central Bedfordshire Council support... the prioritisation of demand management through the installation of smart meters and the reduction in leakage over increasing supply.'

CPRE Norfolk:

'CPRE Norfolk strongly supports Anglian Water in their approach to prioritise demand management of water resource.'

Environment Agency:

'We welcome Anglian Water's proposals to reduce leakage in both the short term... and longer term. It is also good to see a high level of demand management.'

Natural England:

'We strongly support the demand management options in the WRMP...'

NFU:

'We agree that demand management must continue to be Anglian Water's priority...'

Ofwat:

'The draft plan has demonstrated good practice through the focus on demand management to achieve the supply-demand balance, including the setting of ambitious leakage reduction targets across the planning period.'

RSPB:

'We are pleased to see Anglian Water's evident commitment to [demand management].'

Although stakeholders agreed that we should prioritise demand management, the Environment Agency and Ofwat also raised concerns about the scale of our ambition, deliverability, and the risk of not achieving the expected water savings. Understanding these concerns, we have attempted to address them in the following sections of the Demand Management Strategy supporting technical document.

4.4 The customer view

The conclusions from our customer engagement activities are summarised below.

'About resilience'

Our customers told us that ensuring that supply meets demand is one of our most important 'core' services. We should be planning for the long-term and taking preventative action to build resilience to future challenges.

Many customers were surprised to learn about current drought risk and were not previously aware of the severe restrictions that could be implemented during a drought. They were particularly concerned about standpipes, which they view as a gross failure and completely unacceptable in a developed country like Britain.

Generally they felt that rota-cuts should also be avoided, but they were less concerned about them because they anticipate being able to stockpile water when supplies are available. They are, however, satisfied with the current Levels of Service for hosepipe bans and non-essential use bans and don't see these restrictions as a priority area for investment.

Once customers understood that we have a long-term plan to balance supply and demand, they placed more responsibility on us to maintain supplies during a drought. They did not feel we should ignore a known risk, especially when we have a range of solutions to mitigate it.

However, customers will not support bill increases to reduce drought risk unless they can see that we are fulfilling our responsibilities.

This includes doing everything we can to save water, giving customers the tools to save water and use water more efficiently (and therefore money) and investing in additional supply where required.

'About water resource development and demand management'

Customers indicated that they do not want deterioration in service and all water resource options (including both demand management and supply-side options) were preferable to an increase in water use restrictions. (The one exception being sea-tanking, which customers did not perceive to be a credible option).

Generally, customers prefer options that make best use of existing resources and infrastructure, as opposed to options that involve developing new resources.

They indicate a clear preference for demand management, particularly leakage reduction. Even when customers understood that our leakage performance is industry leading, and that reducing leakage does not reduce bills, it remains an emblematic issue and a priority for investment.

Customers said...

'I think that our water company should regard having to put water-restricting measures in place as a failure on their part to plan adequately for the future.'¹¹

'Lots of countries drink entirely from bottled water. But not being able to wash or flush toilets sounds horrible. I think that is where I would draw the line.'¹²

'In the 21st century it is unacceptable to have any of these measures implemented. We are 'paying customers' and water companies have a contractual obligation to supply us. I would forgo having a bath as I seldom do anyway, but other measures would be unacceptable.'¹³

Customers, however, were clear that we must fulfil our responsibilities and take steps to conserve water before we can ask customers to save more water themselves.

Customers told us that they are willing to play their part by reducing their consumption, and accept that they have a responsibility to conserve water.

There was a lot of spontaneous interest from customers in using smart meters and having access to the data which might help them to save money by understanding and reducing their consumption.

Smart meters were seen as a key programme in driving behavioural change and are expected to be the norm in the future.

¹¹ Incling, August 2017, 'Drought resilience: Exploring customer acceptance and buy-in', Page 9

¹² Incling, August 2017, 'Drought resilience: Exploring customer acceptance and buy-in', Page 2

¹³ Incling, August 2017, 'Drought resilience: Exploring customer acceptance and buy-in', Page 20

Customers appreciated the idea of being able to easily access information about their personal water use more frequently, making them more informed and better able to make decisions regarding water usage.

The results from multiple sources show that, generally, customers are much more supportive of compulsory metering than has been the case previously. However, customers who pay measured charges tend to support compulsory metering, whereas those who pay unmeasured charges do not. We believe the higher levels of support for compulsory metering reflect the larger proportion of customers paying measured charges compared to previously.

We currently aim to reach 100% meter penetration, which in reality is approximately 95% of our customers, as this is considered to be a technically acceptable limit above which the cost of metering the remaining households is disproportionately high. The limit to meter penetration is due to those meters which are hardest to reach and replace. (i.e. the most inaccessible internal meters; e.g. flats above shops)

The reliability¹⁴ of water resource management and additional supply options is another important consideration for customers, and generally it is noted that they prefer options that are described as having 'higher' reliability, as opposed to 'medium' or 'lower' reliability.

- For example, in the 'Water Resources Stated Preference Survey' all options were defined as either 'higher', 'medium' or 'lower' reliability. Overall, leakage reduction was the highest ranked option. However, when leakage was described as 'lower' reliability, it was less preferable to some supply-side options described as 'medium' or 'higher' reliability (including water re-use and reservoir extensions).

Although customers express a preference for options which reduce demand, they also want to see the relevance of a cost-effective balance of supply and demand options. When it was explained to customers that there may be cheaper alternatives to leakage reduction, many felt that while leakage reduction is important, affordability should also be a key consideration.

Finally, many customers also recognise our expertise and trust us to make informed choices and complex investment decisions, in deciding upon the mix of solutions that will be most efficient and cost effective.

Customers said...

'Just like folks now using smart meters are less inclined to leave a myriad of appliances on standby it will, through education and individual customer cost savings, become the norm to use water sparingly.'¹⁵

'It is blindingly obvious that Anglian Water needs to BOTH increase water availability AND reduce water usage per person. A two pronged attack is needed in case one or the other fails.'¹⁶

'The approach needs to be balanced and costs vs. benefits of everything need to be considered. Leaks are important to the end user and are visible for domestic consumers - but it's not the only way water is wasted and not the only thing that money can be spent on.'¹⁷

'It's high time smart meters were rolled out across all counties. I will be welcoming the opportunity to upgrade my existing meter. They give you time to adjust your water usage to make a difference.'¹⁸

'My parents always leave the taps running. With my smart data I can say to them 'by the way, you've used my daily usage up by 10 in the morning!'¹⁹

¹⁴ The term 'reliability' refers to the certainty over option yield or saving. For example, how confident are we that a reservoir option will achieve the expected 100Ml/d yield, or a water efficiency option will deliver 10 Ml/d of water savings.

¹⁵ Incling, August 2017, 'Drought resilience: Exploring customer acceptance and buy-in', Page 27

¹⁶ Incling, August 2017, 'Drought resilience: Exploring customer acceptance and buy-in', Page 25

¹⁷ Incling, August 2017, 'Drought resilience: Exploring customer acceptance and buy-in', Page 20

¹⁸ Incling, December 2017, 'Smart water meters: Qualitative insights from the Love Every Drop customer community, Page 7

¹⁹ Incling, December 2017, 'Smart water meters: Qualitative insights from the Love Every Drop customer community, Page 8

‘About bill impacts’

Many of our customers are feeling under financial pressure and are very concerned about money in general. However, there is evidence that suggests rent and other utility bills tend to be much more of a concern than water bills, because they are higher and tend to fluctuate more.

The results emerging from our societal valuation work indicates that customers are prepared to accept bill increases for service improvements that they value. However, this work also shows that there is a big difference between the attitudes of more affluent customers and less well-off customers.

In addition, results from the qualitative research suggest that customers would be prepared to accept moderate bill increases (a few pounds per year), to increase drought resilience.

There is a strong link between affordability and water efficiency. Customers want Anglian Water to support them in their aim to save money, by helping them to understand and reduce their consumption.

‘Sometimes you feel, “I’ve worked all month and I have nothing left.”’²⁰

‘Though already on a tight budget I would pay up to 10% more on my bill if it meant no interruption to my home supply should there be a drought situation.’²¹

‘I would suggest a good quality “money saver” guide, which could be sent out. This should include things like “would you be interested in a water butt, or a poly brick for the cistern? Do you want to save money?” This could follow up with local meetings and a knowledgeable attendance at local event.’²²

4.5 Conclusions

Our customers have clearly indicated their support for further demand management activities.

As stated in our customer engagement report ‘Customer Research and Engagement Synthesis’:

‘Customers generally feel the company has identified the right long-term challenges and goals.’²²

‘With a few exceptions, customers generally prioritise demand over supply-side water resource options. They prefer options that avoid perceived waste (leakage reduction, recycling/re-using treated waste water) and promote efficiency (water-saving devices).’²⁴

‘Supply meeting Demand is regarded as one of the most important of the company’s ten outcomes. Customers are very concerned about population growth and new development; enabling sustainable growth is generally seen as the second most important of the company’s four long-term goals, after resilience (although customers link the two issues). Customers want the company to plan ahead, influence the planning system, and work in partnership with landlords and developers to “design-in” water efficiency.’²⁵

There is a strong link between our demand management strategy and customer behaviour - customers expect us to ‘do our bit’ on leakage, and failure to do this may hinder customer appetite for water efficiency behaviours.

Although our leakage performance is industry leading, leakage reduction remains a priority for our customers, and we should be targeting further ambitious reductions. We should continue to prioritise demand management, and to support our customers to reduce their consumption.

However, customers will not support demand management at any cost, especially where there are cheaper supply-side alternatives. We should seek to develop a strategy that includes a sensible mix of supply and demand options. In determining the appropriate level of demand management, we should have regard to both reliability and cost.

Customer engagement has had a strong influence in shaping our demand management strategy. This includes taking account of customer priorities, but also using the results of our societal valuation studies to monetise customer preferences and choices. Our decision to prioritise demand management activities is in response to the strength of support these activities have from customers.

²⁰ Alto, 2017, ‘Customer Behavioural Segmentation Research Report’, Page 51

²¹ Incling, August 2017, ‘Drought resilience: Exploring customer acceptance and buy-in’, Page 24

²² Incling, August 2017, ‘Drought resilience: Exploring customer acceptance and buy-in’, Page 30

²³ Ahmad, June 2018, ‘Anglian Water: Customer Research and Engagement Synthesis’, Page 24

²⁴ Ahmad, June 2018, ‘Anglian Water: Customer Research and Engagement Synthesis’, Page 30

²⁵ Ahmad, June 2018, ‘Anglian Water: Customer Research and Engagement Synthesis’, Page 29

5. Our Preferred Plan



Our vision and future ambition

We plan to build upon our proven track record of delivering demand management savings, through both our leakage and metering programmes.

We are proposing an ambitious programme of demand management to support our new WRMP; one that provides economic benefits, delivers substantial water savings but is also achievable.

Our previous success, however, does mean that there is limited potential to achieve further savings through 'tried and tested' demand management activities.

Our ambition is to drive the next 'step-change' in demand management through technological innovation and the implementation of 'industry leading' initiatives.

Our Preferred Option - 'Extended Plus'

This ambitious strategy will comprise three strongly interlinked programmes, as described (This has been termed our 'Extended Plus' Option):

Water metering programme

- This will consist of a smart metering programme, which will replace our entire meter stock over 10 years (2 AMPs)
- The information revolution resulting from 'smart metering' will help inform our customers regarding water usage and assist in our ability to influence this behaviour. It will also help with our ability to detect leakage and understand our system.

Leakage reduction

- Our aim is to reduce leakage by more than 70 MI/d by 2045 (Including 28MI/d of CSPL reductions)
- We are aiming to reduce leakage by targeting both losses in our distribution system and losses due to customer supply pipe leakage and internal plumbing losses.

Water efficiency measures

- New technologies and our interventions will help promote the careful use of water by both our household and non-household (business) customers.
- Additional water efficiency programmes will include: A Multi-utility web-portal; Leaky Loos campaign; Rewards schemes 'Bits and Bobs campaign'; A water butts programme; Rebates to replace old toilets; Promotion of 'Smart' devices (taps etc.)
- We are currently working on the next iteration of our engagement with Retailers on non-household (business) demand management, which is in development. This will include a dedicated Wholesale website section providing targeted information for Retailers and also content to be directed towards their end users.

5.1 Our preferred plan and the deployment of demand management options

The importance of managing demand is emphasised in Defra's Guiding Principles, for example: 'We expect you to choose demand-side options as part of the preferred programme wherever it is reasonably likely that the benefits will outweigh the costs'.²⁶

In addition, demand management forms an essential strategy in mitigating short-term environmental risks. Increasing our current abstractions to meet growth related requirements would represent a serious deterioration risk and it is noted that there is envisaged to be no more licenceable water available to meet future demand.

We, therefore, plan to use demand management strategies to offset any growth in demand, mitigating this risk.

Demand management also has wider environmental benefits. It directly benefits our local environment as we are saving water that would otherwise have to be abstracted, increasing the well-being and resilience of natural aquatic habitats.

Avoiding the need for additional abstraction is particularly important in our region, which is home to many internationally important wetland ecosystems and is classified as an area of 'serious water stress' by the Environment Agency.

In addition, water saved does not need to be treated and distributed which reduces our operational energy consumption, making us more efficient and saving carbon.

Additionally, analysis from the WRE project suggests that demand management should be an essential component of any long-term, sustainable water resource strategy for the region.

Reliability:

- We will ensure that our system is resilient to the combined effects of severe drought (defined as an event with an approximate 1 in 200 year return period) and climate change, so that none of our household and non-household customers are exposed to an unacceptable risk of standpipes and rota-cuts.

Sustainability:

- Ensure that there is enough water to meet forecast local authority growth projections.

- Meet all of our statutory environmental obligations, including restoring abstraction to sustainable levels and preventing deterioration in water body status.
- Make best use of available water resources, before developing new ones. This includes prioritising cost-beneficial demand management and trading to share any available surpluses.
- Ensure that solutions for the WRMP 2019 are flexible enough to be adapted to meet unknown AMP8 needs (post 2025), including possible future exports to Affinity Water (Central) and Cambridge Water (South Staffs Water).

Affordability:

- Ensure our preferred plan represents 'best value' over the long-term.
- Minimise the risk of delivering assets that become stranded or under-utilised in the longer term.
- Ensure that investment not driven by statutory requirements is kept within a range affordable for all customers.

5.1.2 Our Preferred Option ('Extended Plus')

We believe there is great potential for increasing future demand savings, driven by innovation and investment.

Consequently, demand management strategies can play a vital role in ensuring that we meet our planning objectives.

Both the government and our customers expect us to continue to reduce demand for water resources. Our customers have told us that they prefer options that make best use of available resources and that leakage reduction should be prioritised.

Within this, we believe, there is great potential for increasing future demand savings, whilst encouraging customer engagement and making them part of the 'water saving' journey.

We have used the results of our 'Problem Characterisation' analysis, together with the outcomes of customer and stakeholder engagement to inform and develop our specific planning objectives.

Our current achievements in demand management limit the potential to achieve further savings through 'tried and tested' demand management activities.

²⁶ Defra, May 2017, *Guiding principles for water resources planning*, Page 6

In particular it should be noted that our standard ‘dumb’ meter penetration currently stands at a very high level, with 81% of our customers receiving a measured bill, (and 89% having a meter 2017/18) with associated behavioural savings (as customers switch from being unmeasured to measured status) already being seen. Additionally, our leakage levels are already significantly below the assessed Economic Leakage level of 211MI/d, at 182.66 MI/d

However, our ambition is to build upon our current position. The next step-change in demand management will be achieved through technological innovation and the implementation of ‘frontier’ initiatives that are relatively un-tested in a UK context.

This ambitious programme will comprise three strongly interlinked strategies, as described (This has been termed our ‘Extended Plus’ Option):

Figure 5.1: Our holistic plan

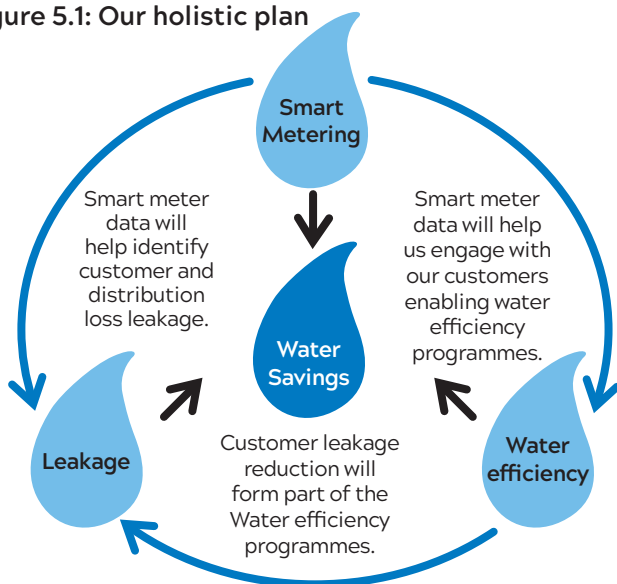

Metering

- This will consist of a smart metering programme, which will replace our entire meter stock over 10 years (2 AMPs)
- The customer data resulting from ‘smart metering’ will help inform our customers regarding water usage and assist in our ability to influence this behaviour. It will also help with our ability to detect leakage and understand our system.
- By the end of AMP7, we estimate that smart meters, combined with the behavioural change and the improvements in leakage performance that they enable, will result in up to 9 MI/d demand savings, and up to 9 MI/d reduction in CSPL. By 2045, we estimate smart meters will result in up to 24 MI/d demand savings, and up to 28 MI/d reduction in CSPL and distribution losses.

Leakage reduction

- Our target for AMP7 is to reduce leakage by a further 30 MI/d (17.5%), from a value of 172 MI/d in 2020 to 142 MI/d by the end of AMP7 in 2024-25.
- Taking 2017-18 as a base year, we are targeting a reduction of 22% from 182.66 MI/d to 142 MI/d in 2024-25.
- Our aim is to reduce leakage by more than 70 MI/d by 2045 to a final figure of 106MI/d, a 40% reduction from our current position (Including 28MI/d of CSPL reductions).
- Leakage currently represents 16% of distribution input (DI) and will represent 9.5% of DI in 2045.
- We are aiming to reduce leakage by targeting losses in our distribution system, losses due to customer supply pipe leakage and internal plumbing losses (which will also impact PCC).

Water efficiency measures

- We forecast that our additional water efficiency activities will result in savings of 6 MI/d by the end of AMP7, and 30 MI/d by 2045.
- New technologies and our interventions will help promote the careful use of water by both our household and non-household (business) customers.

Additional water efficiency programmes will include:

- A Multi-utility consumption web-portal
- Leaky Loos campaign
- A rewards scheme for customers who sign-up on the web-portal
- A base ‘Bits and Bobs campaign’ (up to 15,000 audits)
- Free installation of water butts (when purchased by a customer)
- Provide and install water butts to certain customers
- Rebate to replace old toilets
- Retrofit ‘smart devices’ (such as taps) that can send data to the customer portal

Demand reduction savings for each of these programmes have been quantified, using detailed assumptions and modelling.

5.1.3 Options considered

Reflecting guidance and noting that our demand management measures needed to be considered holistically, we produced a number of variations of the strategic options, including complementary elements of leakage, smart metering and water efficiency interventions. These were characterised into the following option packages;

Baseline

- Maintaining leakage at the current level (177MI/d 3 year rolling average)
- Continued 'dumb meter' roll-out to maximum feasible penetration (95%)
- Continuing current water efficiency strategies

Extended

- Reduction of leakage by 38MI/d to 134MI/d by 2045, by a combination of leakage and smart metering strategies.
- Implementation of smart metering over a 3AMP (15 year) programme to maximum feasible penetration (95%)
- 'Extended' programme of water efficiency strategies
- Total Option savings
 - End of AMP7: 26MI/d
 - End of AMP11: 71MI/d

Extended Plus (the final preferred option)

- Reduction of leakage by 70MI/d to 106MI/d by 2045, by a combination of leakage and smart metering strategies.
- Leakage reducing by 21% to 142MI/d by 2025 and by 42% to 106MI/d from the current value (182.66MI/d) Note leakage currently represents 16% of distribution input and will represent 9.5% of DI in 2045.
- Implementation of smart metering over a 2AMP (10 year) programme to maximum feasible penetration (95%)
- 'Extended Plus' programme water efficiency strategies
- Total Option savings
 - End of AMP7: 43MI/d
 - End of AMP11: 123MI/d

Aspirational

- Reduction of leakage by 105MI/d to 72MI/d by 2045, by a combination of leakage and smart metering strategies
- Implementation of smart metering over a 2AMP (10 year) programme to maximum feasible penetration (95%)
- 'Aspirational' programme water efficiency strategies
- Total Option savings;
 - End of AMP7: 60MI/d
 - End of AMP11: 164MI/d

Our 'Extended Plus' option allows us to innovate and deliver a step change in our demand management activity, while delivering a strong economic case.

The other strategic options do not strike the same balance, compared with our preferred 'Extended Plus' option.

We do not believe that the less ambitious, 'Extended' option goes far enough in delivering the demand management that our customers and stakeholders expect.

The 'Aspirational' option, however, is more expensive and the hoped for water savings are less certain.

Thus, our preferred option (Extended Plus) has been assessed to 'best meet' our multi-criteria approach to selection, meeting customer need, mitigating growth and meeting all our obligations.

Table 5.1: Comparison of assessed options against our selection criteria

Criteria	Extended Option	Extended Plus Option (Preferred)	Aspirational Option
Meets Customer expectations	Red	Green	Yellow
Reasonable Cost	Green	Green	Red
Mitigates Growth	Red	Green	Yellow
Fulfills Regulatory Obligations	Red	Green	Green
Aligns with WRE	Red	Green	Yellow
Is deliverable / achievable	Red	Green	Red
Meets SEA requirements	Red	Green	Green

‘Extended Plus’ will form part of our ambitious and deliverable twin track approach, of using demand and supply solutions, to secure future water supplies.

As can be seen, in totality, in our preferred option package, the demand management programmes should effectively mitigate the growth impact from demand.

Figure 5.2: Demand reductions from our preferred strategy compared to forecast growth (AMP average)

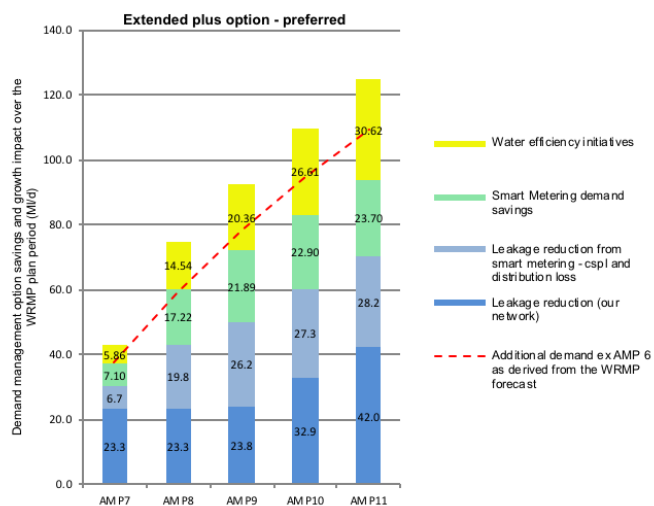

5.1.4 A Strong business case

Our preferred option is the most cost beneficial of the three strategic options that we have evaluated.

The costs and benefits of this option are shown in the figure below. The figure shows clearly that the option is significantly cost beneficial - this is partly driven by the level of water savings we will achieve, which allow us to offset supply side investment. The option remains cost beneficial under a number of sensitivity tests as described in section ‘7. Costs and benefits’.

Figure 5.3: Total costs and benefits (25 year incremental NPV)

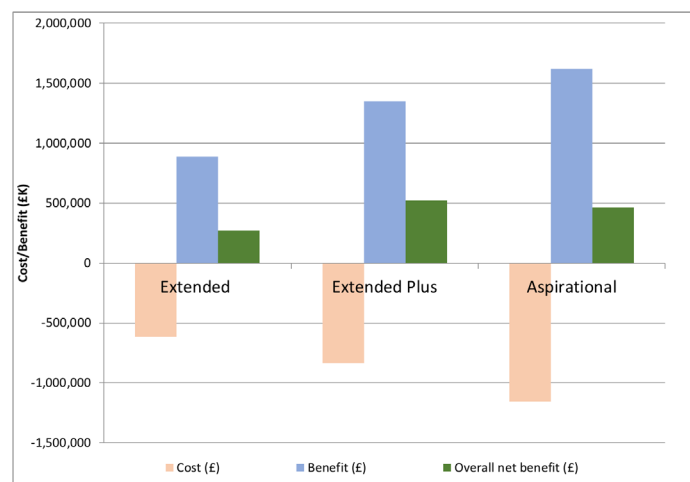

The cost of our demand management strategy is £255 million (totex) in AMP7. This does not result in an impact on the average customer bill as the costs are offset by the additional revenue from new connections (assuming that forecast growth materialises). We have undertaken an assessment of

costs and benefits which shows that our strategy is cost beneficial.

Costs can be shown for the 25 year period (AMP11) as below;

Table 5.2: Demand management option costs over the 25 year plan period

	Capex (AMP11) £k	Opex £k /yr	Opex saving including value of water saved £k/yr	Finance Costs (AMP11) £k	Total Cost including finance and Opex savings (AMP11) £k
Leakage programme	£72,632	£1,420	-£1,810	£62,001	£344,272
Smart Metering programme	£343,113	£10,084	-£10,539	£138,665	£470,412
Water Efficiency programme		£3,717	-£1,395		£58,064
TOTALS	£415,746	£15,222	-£13,743	£200,666	£872,748

5.1.5 A plan that best meets customer expectations

There is clear support from customers for further demand management activities, with leakage reduction remaining a priority for our customers.

However customers will not support demand management at any cost, especially where there are cheaper supply-side alternatives. Customers also value options that are reliable.

Our preferred plan best meets customer expectations of continued improvements in reliable demand management at an affordable cost.

5.1.6 Striking the right balance between affordability and the environment

We have an important role to play in protecting the natural environment. It is important to us to act as stewards of the natural environment and to be leaders in environmental protection.

Demand management is essential to mitigating short-term environmental risks.

Increasing our current abstractions to meet growth related requirements would represent a serious environmental deterioration risk.

By choosing 'Extended Plus', we are using demand management to offset any growth in demand, mitigating deterioration risks.

The 'Aspirational' option also offsets demand growth but this option has a weaker business case than 'Extended Plus' and is more expensive. We believe that 'Extended Plus' strikes the right balance between protecting the environment and ensuring affordability.

5.1.7 An ambitious, but achievable plan

The results of our analysis, the Water UK WRLTP and WRE show that we should be aiming to enhance our demand management activity to secure future water supplies.

Our 'Extended Plus' plan represents an ambitious extension to our existing demand management activities; incorporating innovative initiatives to deliver further water savings. It will facilitate further leakage reduction, driving the performance frontier in the UK, and utilise new smart meters which unlock a host of other activities to deliver water savings that can offset projected demand growth.

The scale of our ambition is illustrated in the figure below, which shows the percentage change in the number of properties supplied, the water we put into our network and leakage since 1998.

Figure 5.4: Demand management: past achievements and future ambition

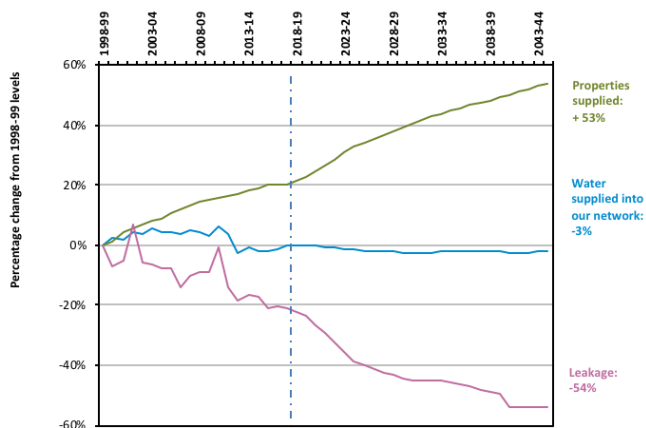

In terms of actual demand, without demand management consumption (DYAA) DI is forecast to rise by 109MI/d.

With our preferred ‘Extended Plus’ management option this is completely mitigated with consumption in 2045 set to decrease by 18MI/d from the initial 2020 value (1130 MI/d).

Figure 5.5: Consumption with and without the ‘Enhanced Plus’ demand management strategy

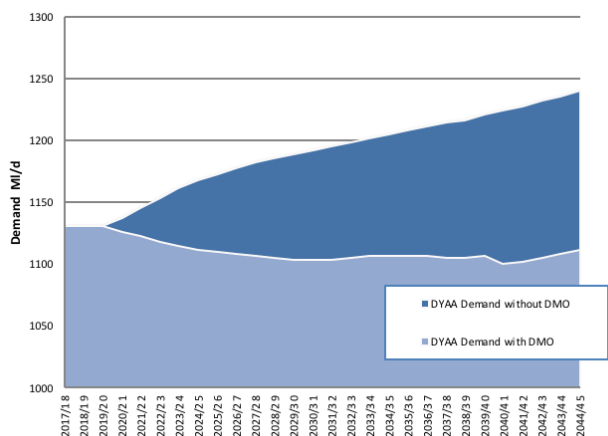

The impact of our demand management strategy on per capita consumption (PCC) is shown in the figure below.

By the end of the period (2045), we expect that our average PCC will be 120 l/h/d, a reduction of 14% (16 l/h/d) compared with 2017/18.

This aligns with national expectations and is in accordance with our neighbouring water company WRMPs.

Figure 5.6: the impact of our demand management strategy on average per capita consumption (PCC)

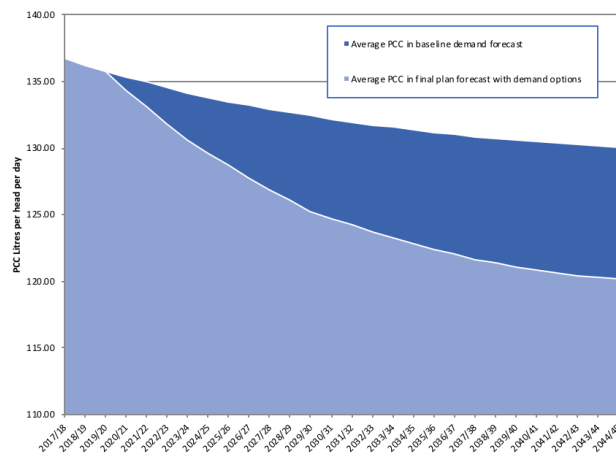

Additionally, building on our current position, leakage will reduce from the current position, representing 16% of water put into distribution (Distribution input (DI)) to less than 10% by 2045.

Figure 5.7: Leakage as a percentage of distribution input (demand)

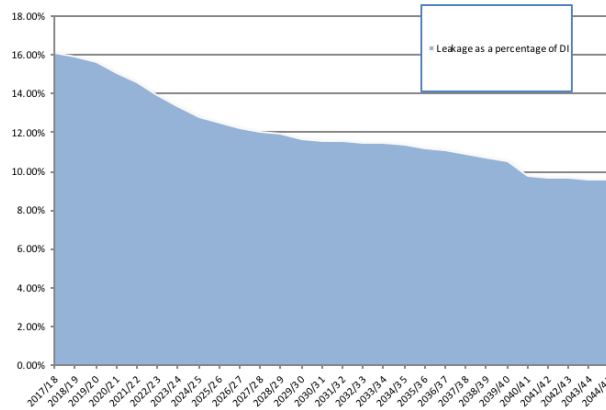

Our ambitious demand management strategy is made up of many activities within our control.

However, in addition to this, we believe that with the support of the Government and other stakeholders, it will be possible for the UK water sector to deliver further significant demand management savings.

Through our engagement with the government and the National Infrastructure Commission we hope to support the development of the following measures:

- For new homes, discounts for water efficient buildings could be supported by clear messages from government as well as local authorities requiring increased water efficiency.

- The introduction of a single water efficiency label covering bathroom, kitchen and garden products has been slow. This should be on a par with labelling of product energy efficiency ratings.
- New regulations have a part to play; in particular Water Fittings Regulations could further prevent

waste, and higher bills for individuals that arise, from leaking toilets

Thus, our preferred plan will focus on the following activities...

5.2 Data, smart metering and customer usage

Metering, enhancing customer communication and the drive for behavioural change

The smart meter technological revolution will support our water efficiency behavioural change activities, through the provision of real time consumption data for both our customers and ourselves.

The central imperative, which drives the 'smart meter' option, is the generation of data for our customers, so that they and we can understand water usage and help drive behavioural change.

This will reinforce current water savings as customers become metered and measured and unlock the potential for additional water efficiency measures in a mutually reinforcing way.

Smart metering should also facilitate significant benefits for leakage reduction through the more efficient and timely identification of leaks. This identification of leakage will inform our home visits, adding significant value to our water efficiency activities.

Consequently, the systems that we invest in must be robust and, critically, must be able to supply accurate and reliable data over the long term. This requirement has been foremost in our current thinking regarding our smart meter trials, and the selection of systems able to collect and transmit this data, given the conditions that pertain to where and how data can be collected.

Under our preferred smart metering option, we intend to install smart meters across our region, reaching the limit of feasible meter penetration (95%) by the end of AMP8 to provide detailed daily usage data to our customers and for ourselves. This data will be provided daily to customers through a dedicated website or 'customer portal'.

This will involve a major installation and replacement programme, for all our current 'dumb' meter stock (over 2 million meters) with new 'smart meters' over a 10 year period.

By the end of AMP 7, we estimate that smart meters, combined with the behavioural change and the improvements in leakage performance that they enable, will result in up to 9 MI/d behavioural demand savings, and up to 9 MI/d reduction in cspl. By 2045, we estimate smart meters will result in up to 24 MI/d behavioural demand savings, and up to 28 MI/d reduction in cspl and distribution losses.

Our preferred option will give the greatest level of benefit to our customers, allowing us to develop an individually tailored customer service.

5.2.1 Current position and overview

Anglian Water currently has one of the highest rates of meter penetration in the UK. In the current year 2017/18, we have over 89% of household properties with installed meters and 81% of customers paying measured charges.

We believe that metering is the fairest way to charge for water, because customers only pay for what they use.

It has been found that customers who are metered and billed on their measured usage generally use less water than customers who pay an unmeasured estimated charge (this savings has been assessed to be 15%).

We have consistently sought to increase the number of customers who are metered and billed on their measured usage, without a compulsory metering programme. Generally our customers agree that it is fairest to pay for what you use, but they do not think we should make metering compulsory.

Our target during this AMP (AMP6) is to install a total of 86,000 new meters. This would see 91% of our customers metered and around 85% paying a measured charge.²⁷

There is a discrepancy between the number of customers who have a meter installed and those paying measured charges. This is related to our current policy of not switching customers to measured charges on a compulsory basis, even when we have had the opportunity to install a meter. As such, if customers do not want to switch to measured charges we wait until there is a change in occupancy, or request to opt in, before changing the premise to measured charging.

Around 90% of the currently installed meters are 'dumb' (that is they do not 'speak' or provide data remotely), so they have to be read manually.

Manual reading requires significant operational input and staff, only allowing measurements to be collected over long periods (6 monthly).

Consequently, infrequent customer usage data is only available, which does not allow detailed information regarding 'real time' customer use to be collected.

Currently, these delays in the gathering of data lead to low levels of engagement and severely limit the potential of relaying price signals to customers.

(i.e. indicating increased water usage and, therefore, increased costs). Additionally, the detection of customer supply pipe leakage and internal plumbing losses is only possible on an infrequent basis.

The remaining 10% of current meter stock are radio meters, which are installed inside properties. These allow the possibility of gaining much more frequent data regarding consumption.

These meters are read using drive by readers, installed in vehicles, at more regular intervals (Hourly data read once every two weeks). However, the data available from this type of meter installation is not currently reflected in customer billing frequency or information provision.

Maintaining our current 'dumb' and 'radio' metering stock and billing our customers using measured charges at 6 monthly intervals will be business as usual for us.

Understanding that we have already achieved significant demand savings through our extensive 'dumb' metering programme, further reductions in water usage and behavioural change will require us to consider new and innovative approaches and to look to a new generation of metering and communications technologies.

5.2.2 Data, smart technologies and the future

'Smart' interconnected technologies and the remote collection and transmission of information are a rapidly developing area. We are, therefore, actively planning how we can upgrade our assets with smart technology to capture more data, improve our understanding of our business and improve the productivity of our infrastructure.

We also understand how crucial data will be as an enabler, building towards a new relationship with the customer, in which we can assist them to make informed choices regarding their behaviour and their water consumption.

The collection of real time granular daily and hourly household consumption data will enable us to build a much more dynamic relationship with our customers and radically change how we might influence behaviour.

This abundance of data will be the most important aspect of the new smart metering world.

²⁷ The difference results from our Enhanced metering programme, where we compulsorily install meters, but then encourage the customer to switch to paying measured charges voluntarily. Properties are switched to measured charges on change of occupier.

5.2.3 Smart meter development

The current development of smart meters has been primarily driven by their roll-out in the energy (gas and electricity) sector along with developments in other sectors, including other regions of the water sector in the UK.

While the energy smart meter roll-out is informative, for the water industry, differences in the characteristics between water and energy metering means that careful consideration is needed to determine the optimal solution for us.

- Particular challenges for water smart metering include the potential location of the meter, in that water meters are mostly placed outside of the home without a power source. Thus external meters require an integral power source, and the location may impede the transmission of data

We think smart metering and the data that this will provide will be a critical tool for allowing customers to understand their consumption and manage their demand, being the key to many additional methods of interacting and influencing customer demand.

Preliminary results from our customer engagement for PR19 and societal valuation shows that customers expect us to actively consider smart meters.

5.2.4 Smart meter trials

To inform our decision making process, we are currently conducting a number of trials using smart meters that can provide greater granularity and detail on customer water usage. This has allowed us to investigate types of technologies, installation issues, methods of data collection and data integrity and also new methods of communicating with our customers.

These trials have been designed to inform our future business plans and help us identify an innovative, ambitious and achievable metering strategy fit for the 2020s and beyond.

Our on-going trials are outlined:

- **Colchester** - In this area roughly 21,000 radio meters have been installed and targeted by a 'mobile' network of passive readers fitted to council refuse lorries. The data is collected weekly. Customers are provided with information on their consumption through a web portal.
- **Newmarket** - In this area around 6,000 'advanced meter infrastructure' (AMI) meters have been installed in 4 DMA (District Metering Areas).

Meter readings are collected by the fixed network and transmitted daily to the cloud. Customers are currently provided with information on their consumption through a web portal. We are working on integrating the portal to customer billing information. This trial forms part of our wider 'Innovation Shop Window' trials taking place in Newmarket.

Data has been collected from January 2017, which has allowed us to analyse customer data from both the calendar years of 2016 and 2017 and make informed initial comparisons.

- **Norwich** - This is a larger scale version of the Newmarket trial with a planned roll-out of 12,000 AMI smart meters. This commenced in October 2017 and will start to yield data from February 2018.

The parts of Newmarket and Norwich used for the trials are very different demographically and have a differing mix of internal/external meters. Consequently, we feel that when combined together, they give a good representation of our wider region, giving confidence in the viability of the roll-out and anticipated savings.

These trials have been vital in informing a metering strategy that is ambitious, engages customers and is cost effective. These trials are on-going and final results are now becoming available.

5.2.5 Our smart meter strategy and the criticality of data

The central imperative, which drives the 'smart meter' option, is the acquisition of data, to help understand water demand and drive behavioural change.

Consequently, the systems that we invest in must be robust and, critically, must be able to supply accurate and reliable granular data over the long term.

This requirement has been foremost in our current thinking regarding the selection of systems able to collect and transmit this data, given the severe conditions that pertain to where and how data can be collected

Thus, under our preferred smart metering option, we intend to install AMI meters (monitored through a fixed network) to provide detailed granular daily usage data to our customers and for ourselves.

5.2.6 The currently preferred technological solution

Our preferred solution involves smart meters and smart point transmitters. In this system, data is passed from the 'smart meter' to a 'smart point' on the under-surface of the meter box, which then transmits this via a radio mast network. This is necessary as many external meters can be located at depth, where signals would be lost.

Figure 5.8: Configuration of 'smart meter and 'smart point' in the meter box

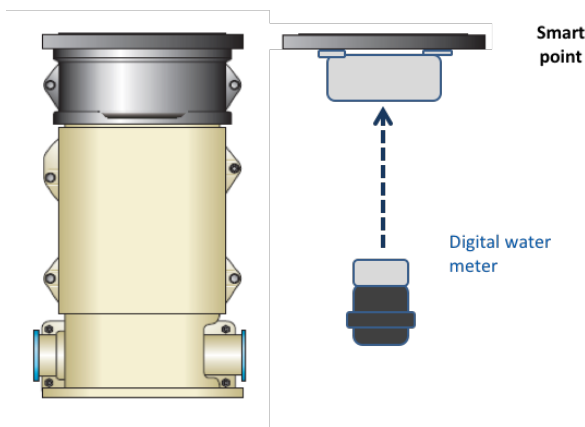

This technology (as tested in our trials) allows hourly readings from the customer meter. Under the currently tested system, the data will be transmitted every 4 hours, (transmitting the last 12 reads each time).

This means that we have several opportunities to capture each hourly read. These multiple reads (and data redundancy) will be key to ensuring data accuracy and consistency, as the data is processed and analysed.

Data is then sent to our systems twice a day. Currently we receive the previous day's data, (e.g. Today's data will be visible to us from midday tomorrow) however, the planned system is implemented; we expect to get as near 'real time' data as is feasible.

With regard to this data acquisition process, we currently envisage using a managed service from a proven supplier for the WRMP/PR19 plan.

The key outcome of this will be the data that we receive, not necessarily the final technical solution we use.

Figure 5.9: Technology used in the current trial

1. 'E-R water meter' measures water use and automatically transmits reads to 'Smart point'

2. 'Smart point' transmits the meter readings to central mast.



Potentially the network system may be operated as a managed network (as in the Newmarket trial), in order to, minimise risks in terms of the quality of data and also, minimise the potential scale and disruption of the installation of the network systems required.

This would mean that the network operator would be responsible for all issues with the network (planning, installation, maintenance) and data transmission (quality and timing).

5.10: Data transmission from the customer to Anglian Water

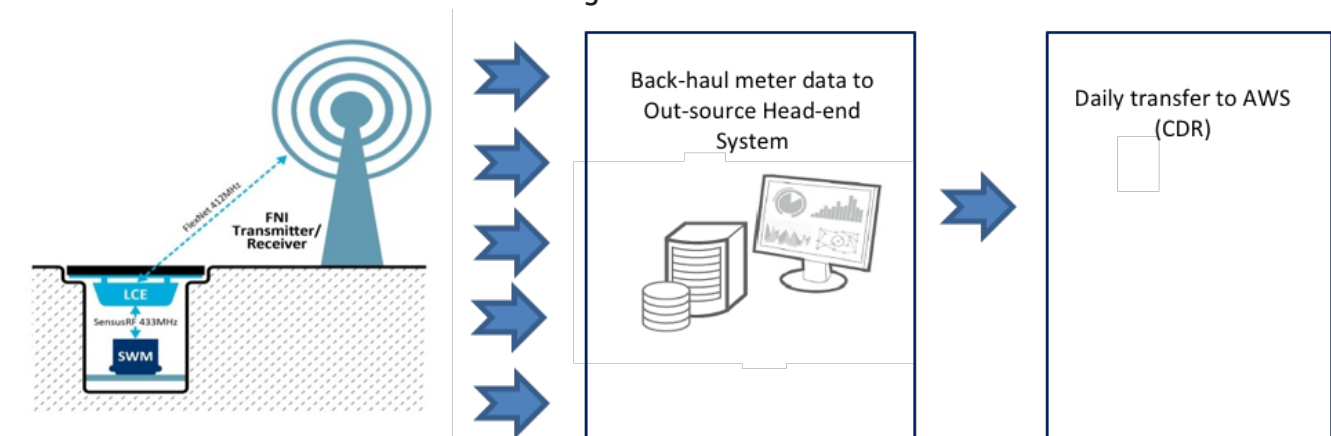

5.2.7 Meter installation roll-out

Under our preferred smart metering option, we intend to install smart meters across our region (monitored through a fixed network), reaching the limit of feasible meter penetration by the end of AMP8, in order to provide detailed granular daily usage data to our customers and for ourselves. This data is then provided daily to customers through a dedicated website or 'customer portal'.

This preferred option will give the greatest level of benefit to our customers and will involve a major installation and replacement programme, for all our current 'dumb' meter stock (approx. 2 million meters) with new 'smart meters' over a 10 year period. Additionally it will include the installation of meters in new developments (Currently projected to be approximately 280,000 new properties from 2020-2030).

The roll-out has been devised to reflect a number of operational and risk based factors including; operational considerations (staffing), current meter penetration, population, expected growth and supply demand issues.

Additionally, it has been devised so that the network and meter installations will be completed area by area (Planning Zone (PZ) and Resource Zone (WRZ)).

This will:

- Allow the meters to be rapidly 'switched on' as they are installed (with meter installation and network mast installation being carried out in unison), meaning that benefits can rapidly be realised.
- Ensure that areas will be completed with similar technology, such that, as technologies improve they will not be randomly distributed across the region, so as not to leave stranded assets.
- Mean that WRZs will be completed in sequence, targeting higher risk areas as a priority.
- Distribute the installation roll-out evenly across the region, whilst maximising the speed that the benefits can be passed to our customers.
- Allow targeting of our customer engagement, area by area.

Obsolescence and technological change has been considered, in that the geographical roll-out of contiguous areas will protect us, to some extent, from future technology improvements. Future changes in communication technology or in the smart meter itself will be able to be incorporated into the planned roll-out area by area, as it is progressed.

The ultimate roll-out will be confirmed once the procurement of the communication technology has been finalised, with the award being planned for summer 2019. If, at that time, a region wide network is not available, it is likely that we will commission this network area by area.

Each area network will be commissioned prior to the installation of the smart meters in order to enable our customers to instantly access their consumption data post smart meter installation.

The geographical based roll out will allow us to actively promote the smart meter programme locally, tying in local community water saving initiatives and benefits.

Figure 5.11: Roll-out of smart metering programme across the Anglian Water Region (2 AMP - 10 year)

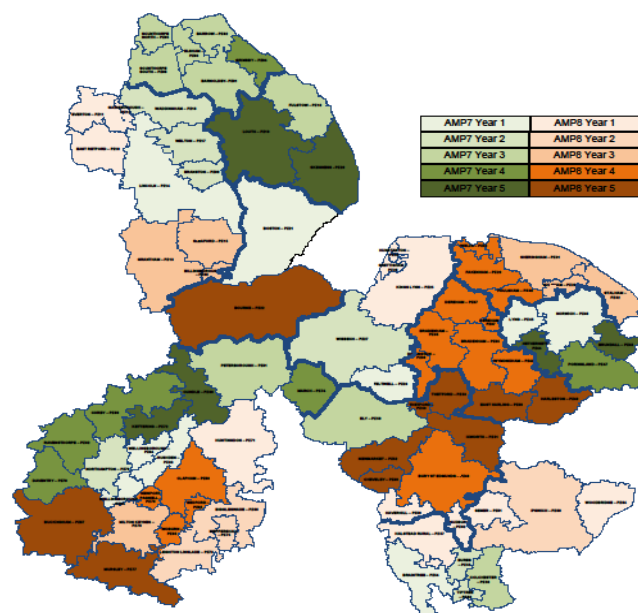

5.2.8 Roll-out risks and issue

Installation resources

One of the main risks identified to the successful delivery of smart metering is the increase in meter installation resources compared to AMP6.

The majority (87%) of our meter stock is located in a boundary box external to the property. This makes the replacement of these a simple and quick operation.

However, in order to deliver our programme, we will need to increase our current level of resource considerably (by 50%). In order to facilitate this we will transition our existing meter reading resource (which will no longer be needed to visually read

meters, post smart meter introduction) into this pool of meter installers.

A geographical roll-out of smart meters will again support this transition, as the meter readers will be able to switch over cleanly. This, together with some targeted trainee schemes, will deliver the required levels of resource.

Internal/External meters

We know from our AMP6 replacement programmes that internal meters are harder to replace than external ones because access is required to replace the meter.

Due to our high level of dumb meter penetration, we record which type of meter is installed across our region.

We are, therefore, able to identify areas which have a higher than average percentage of internal meters installed (Grimsby and Scunthorpe).

Whilst we have a better success rate when installing a smart meter (rather than with a visual read meter) we have addressed this increased difficulty in two ways.

- Internal smart meters will not be installed on a geographical basis. We will smooth the installation programme over the whole AMP to allow us to employ a stable plumbing resource to install all the intended meters.
- We will also only access the property once in the AMP.

Both of these actions will mean that we will install smart meters before the network is ready to receive the data. In these situations the meters will remain in AMPR (non-transmission) mode until the network is ready, and the customer will then switch over to the smart meter system and portal, as outlined earlier.

Final installations

One disadvantage of the geographical roll out is that it will mean some areas will not be smart metered until the end of the 10 year programme in 2029/30.

This may result in some customers who actively want a smart meter, feeling disenfranchised, having to wait longer than they would like.

We are currently considering a number of technical solutions to this problem and will confirm our final approach, once we have selected our final option for the communications network.

Smart meter 'opting in'

We are also currently exploring a method of allowing optants to choose to be 'smart' in other areas.

This may depend on which communications technology we finally adopt. If a region-wide already functional network were to be available (very unlikely as none are currently existent), then this might allow us to offer smart meters to any customer upon request. However, if as expected, we have to partner with a network supplier we will have limited potential for this in the early years.

Home WiFi may be an option, however, no one is currently exploring this and issues still arise from the fact that our meters will be outside the home, underground and on battery power. This technology may be possible in future AMPs, but is extremely unlikely for AMP7. We will continue to work with these industries in developing potential solutions.

Smart meter 'opting out'

We have also considered customers who actively might 'not want' a smart meter.

We believe that we have a legitimate interest to install smart meters and collect data for operational reasons such as network management and leakage control. As discussed the benefits from smart metering will be best realised by achieving high levels of meter penetration

We are clarifying the impact of GDPR on our future plans now. We will have to either;

- Give Customers an option to opt out or
- We will have to actively seek Customers permission to store the data.

This will be clarified once the impact of GDPR is better understood. We will incorporate either of these into our future plans.

5.2.9 Procurement

In the current trial the 'network operator' is responsible for collecting and cleansing data. In this process duplicates are removed and the clear complete data sent to us.

It is likely that we will change this requirement to raw data in the procurement process, as this will allow interrogation of the data in more detail. This data will go into our EIM data lake with a platform sitting on the lake which will extract and push the data to our internal systems and external customer website/app.

Note the current systems for the metering trials were all instituted through competitive bid (cost of meter installation/network).

We will go to market next year for procurement of meters and network for AMP7.

The programme will be delivered sectionally, in that we will buy any assets fitted below ground (the smart meters and smart points) and seek a managed service for the above ground communications network.

Our current meter framework expires at the end of AMP6 and we will go to market for a future meter contract again at the end of AMP6. It is likely that any associated 'smart point' will also be included in this framework as a separate lot.

We will seek to develop the framework for the procurement for the communications network and data systems later this year, with the award being planned for the summer of 2019.

5.2.10 Alternative systems under consideration

Currently, there are three possible technological solutions, each with different degrees of risk and viability.

Option 1:

This solution involves a managed communications network service providing data at agreed Service Level Agreements (SLAs).

Below ground assets would be owned, installed and maintained by Anglian Water, providing data into the network.

This solution would allow us to avoid managing the risk of installing and running the above ground network. The disadvantage is that there are not many network companies, operating in the UK currently with few proven services. The companies currently available can provide this service, but at a premium.

Option 2:

This solution would involve Anglian Water owning, installing and operating both the communications network as well as the below ground assets.

This solution whilst deemed cheaper to implement is more risky in terms of rolling out the network and ensuring that reliable regular data is received. There are no known solutions like this operating on a large scale anywhere currently.

Whilst it is technically possible it is far from clear how robust this solution would be and the challenge of commissioning the network and installing the masts should not be underestimated.

5.2.11 Network options

We have supported a number of small scale trials of alternative systems of data transmission, including LORA and NBIOT systems, with a view to determining their applicability.

We are also seeking to engage telecommunications providers in partnership with meter manufacturers. (This would fit into the Option 1 solution as set out above).

However, both of these technologies have only a small to medium range in terms of signal transmission (0.5km as opposed to 5km for the current network system being trailed in Newmarket). Due to this small range and the large geographic area of Anglian Water, it is not clear how many masts would be needed to cover our whole region to support this technology.

Currently there are no suitable region wide communications networks in operation. It is not clear how quickly this will occur or which technology will be selected. This is proving difficult for the metering manufacturers as they are seeking to understand what to build into their meter and/or smart-point to enable them to connect to the network of choice.

Some meter manufacturers are also developing their own solutions to data transmission independently (Option 2 above).

However, in order to adopt these systems, we would take responsibility for the installation of the communications network accepting the high risk and expense involved, in adopting unproven technologies.

Thus, the current evaluation has been that we potentially should use a proven (long range) data transmission system, operated as a managed network, in order to:

- Minimise risks in terms of the quality of data and,
- Minimise the potential scale and disruption of the installation of the network systems required.

It is of note that the actual meter will be the least risky element of the technical installation, as this can be provided by many alternative suppliers.

The 'Smart point' (on the meter point lid) will be more crucial as this 'must' deliver the data to the system. This has to work in transmitting the data, as otherwise the entire system will fail.

Our current thinking is that the 'smart point' will be a separate asset to the meter. This should place the transmission point nearer the surface and will greatly increase the chance of getting the data transmission out of the meter chamber. However, we will also

explore the option of an integrated meter and smart point during the procurement process, but the key selection criteria will be data transmission.

Due to the speed of technological change we will institute a process to continually review developments as the roll-out progresses.

With regard to these three separate items, current thinking is that there will be:

- One procurement framework for Meter
- One procurement framework for 'Smart Points'
- One procurement framework for masts - network.

5.2.12 'Big data' and the customer journey

The smart meter system, by its nature, will generate significant volumes of data, necessitating a revolution in the way we engage with our customers.

- At the rate of one read per household per hour, this will generate over 20 billion reads per year (excluding the duplication of reads for data validation, which will multiply this further).

We believe there is great potential for smart metering to encourage customer engagement, making them part of the 'water saving' journey, and allowing us to produce an individually tailored customer service.

In order to maximise the benefit our customers will gain from the detailed water usage data that will be available, we have been trialling a variety of methods of providing this information.

Initially we considered and trialled display units for our customers, however, technologically it is difficult to facilitate with our external meter stock. Potentially, such display units could more easily be used with internal meters, but this could only be utilised by a proportion of our customer base.

Consequently, we have given more consideration to the concept of a Web Portal and Mobile Applications to deliver information to customers.

We have, therefore, built a standalone customer web portal for the purposes of the AMP6 smart meter trials (This is termed 'My Use').

Our current roadmap for development is for this portal to be integrated into our 'My Account' website in AMP6, such that consumption and billing information can be integrated.

A 'My Account' mobile (phone) application is also being developed as part of the CXTP programme.

In our 'smart meter' trials in Newmarket and Norwich, consumption information is shared with customers on a daily basis through an online portal. This allows

customers to see their water use in more detail than ever before, noting that there is a requirement for immediacy of read data to engage customers.

In addition to the portal, customer communications will be targeted with customer questionnaires, in order to categorise customer demographics and give an initial indication of whether the customer is a high/low/average user, in comparison to a similar cohort.

We will work to ensure that these questionnaires are very focused on the key information that will help both our customers and our future engagement (helping to determine occupancy, no. of toilets, etc.)

We have issued regular paper water reports to customers in Newmarket and Norwich. These set out the customer's water usage in comparison to other similar households and offer some water saving tips.

Thus, customers can compare their water use to other similar households.

To date Customers have been very positive in wanting the consumption data and we haven't seen any negative comments about intrusion. Customers generally trust us to collect only the data that we need and see the benefit of what we're trying to do. However, we do understand that we will see some Customers who do not want us to collect this data as we roll out region wide.

Figure 5.12: Example of water usage communication

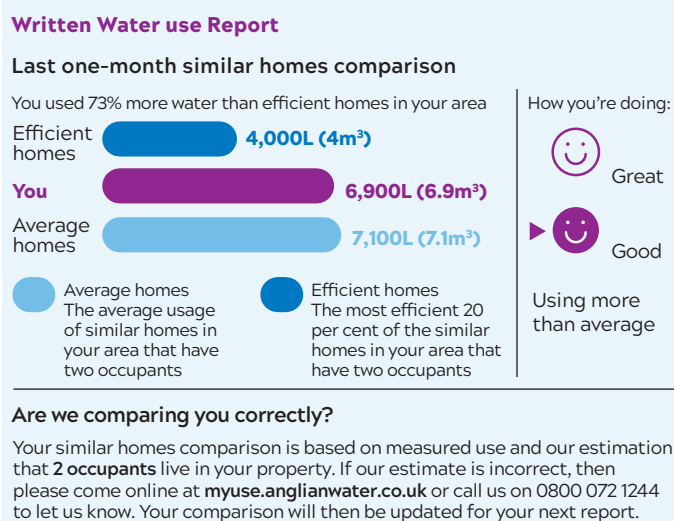

Alongside the information on their water usage the customers will also be able to access tips on how to save water, pledge to change their water behaviour and track the effect of the change on their water use. We are currently exploring additional benefits of an online portal by:

- Linking billing and consumption information, and
- Providing incentives for behaviour change.

Figure 5.13: Example of water usage ‘tips’

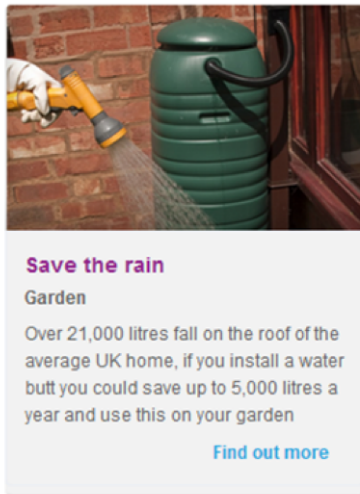

We also intend to include in the updated ‘My Account’ portal, the ability to offer rewards to customers and/or their local community. These rewards would be available when certain milestones are achieved. Additionally we envisage that the customers would be involved with setting the level (and degree of difficulty involved) of the milestones and the potential level of reward.

We are currently reviewing the form that these rewards might take, (they may range from a free coffee up to some water saving technology; community rewards may involve contributions to a local playground, for example).

We are conscious that developing and maintaining customer engagement, will be key to customer satisfaction and achieving the demand reduction goals we have set.

We will, therefore, be keen to ensure that the design and presentation of information to our customers (via the web-portal and mobile applications), should be clear and keep customers engaged. (facilitating the demand savings in the plan). This process will require continuous monitoring, validation and update as the smart meter roll-out proceeds.

5.2.13 ‘Explorers’ and ‘Sentinels’

It has been considered that there will be a difference in how data is initially used by the customer and how it might be used long term.

In our trials in Newmarket and Norwich we have seen two distinct types of customer engagement. This pattern aligns with that experienced in other utilities, such as the gas industry.

Explorer Phase

When the smart meter is initially installed customers actively engage with their water use and seek to understand where and how they consume water. This is the phase when they identify wastage, set long term goals and start to make changes to their behaviour that will reduce their water use. We call this the Explorer phase.

We are currently exploring how to provide information on particular consumer usage (baths/showers etc.) within our trials. Early indications suggest that personal tips based on what the customer has told us about where they use water will help support the behaviour changes we need.

Note this will require accurate data and there will be little room for error for the initial customer data feed, as this will be very highly scrutinised by customers.

Sentinel Phase

Once customers have achieved their new target and removed all the surplus usage they have identified, they will no longer see a reduction and start to see their new, lower baseline water use profile. This is where the second stage starts.

Customers move into a Sentinel phase, whereby, they use the information to ensure they stay at their new base line. They also use the data to monitor usage and assure themselves that there are no leaks or problems with their supply. In this instance the system should indicate divergence from the norm.

This is the more enduring phase. During this phase we will continue to offer tips and advice on how they reduce their usage further, helping them to stay engaged.

Comparisons between different customers, neighbourhoods and demographics will also be possible and may be of assistance in highlighting different profiles in usage and in influencing behaviour. Additionally, daily monthly and seasonal comparisons in usage will also be possible.

As part of this ‘Sentinel’ process we intend to create automatic processes, which will use the smart meter data (specifically night flow data) to identify customer issues (such as supply pipe leaks or internal plumbing losses). We will then help the customer to identify potential leaks and will then monitor the customer’s consumption whilst they fix the issue. We have trialled this approach in Newmarket and Norwich with great success (as shown in the case study below)

5.2.14 Determining a realistic value for smart meter savings

We have been keen to ensure that potential demand savings, that might be facilitated by the introduction of smart meters, are achievable and are realistically reflected in the plan.

We have, therefore, conducted detailed independently verified, analysis of household data from both our Newmarket and Norwich trials. This has determined values observed for cumulative and year on year changes in ADC (Average Daily Consumption per property); comparing values from 2017 and 2018.

Additionally the Newmarket trial data has been compared to our internal regional consumption monitoring data, as a 'control'.

Key to the detection of plumbing losses and customer supply pipe leakage, is continuous flow data, from the hourly reads.

Thus, the availability of night-time 'continuous night flows' allow the detection of flows when customer usage should be at a minimum or zero which typically indicate leaks in the system.

Observed reductions in consumption due to cspl and plumbing losses in Newmarket smart metered (and measured) domestic properties to date (January and February 2018) have been found to be between 20 and 26 litres per property per day.

Figure 5.14: Comparative consumption with and without smart meters (Newmarket)

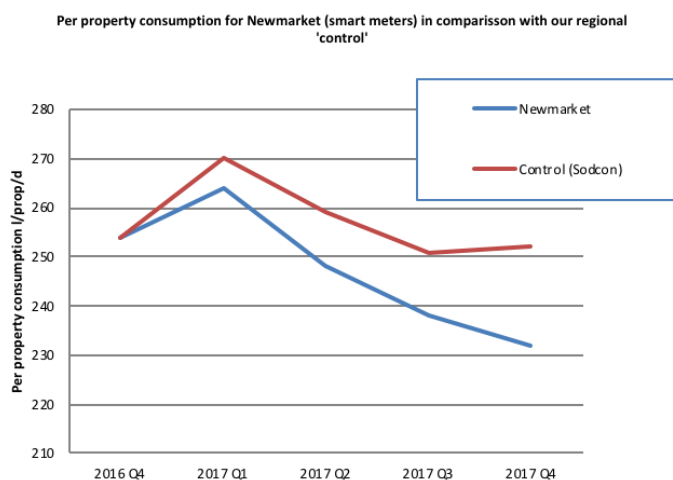

Of this reduction, the majority, 15 and 20 l/property/d, is attributable to 'Plumbing Loss' reductions and, the remainder, between 2 and 6 l/property/d from changes in behaviour.

This corresponds to an overall percentage reduction of between 6.0% and 7.9% in total per property consumption (from a value of 252 l/property/d)

In reality demand savings seen from both trial areas are actually higher than those we are using for planning in the WRMP.

Despite these very encouraging figures, we have decided to include a smaller assumed figure for the potential smart meter savings from behavioural change of 3% (when changing from dumb metering to smart metering) and a value which is approximately equivalent to 3% for savings from reductions in cspl and plumbing losses (this has actually been determined from the no. of large and small leaks that are seen to be rectified upon detection (90% of large leaks and 10% of small leaks)).

- Note that large internal leaks have been found to be on average to be in the region of 500 l/property/day.

This more conservative figure aligns with findings from the wider water industry and gives us confidence that the anticipated savings set out in the WRMP will be deliverable.

Using this assumption will reduce the risk of over confidence in the planned savings. It will help account for any additional issues with regard to differences that might be found between the Newmarket trial area and the wider Anglian Water region in terms of demographics and installation.

Additionally, using a smaller value will help account for 'decay' reductions in the savings over time, as the technology is introduced. It is thought that the savings we see may reduce, as customers move from the 'Explorer' to 'Sentinel' phase, and as the technology loses its novelty. We will actively monitor these savings, as the technology is introduced, adapting our customer engagement strategies to maintain engagement over time.

5.2.15 The definition of leakage and customer consumption

The relationship between the expected leakage savings from the smart metering programme and their impact on our leakage and consumption (PCC) targets is defined according to UKWIR Guidance (Components of demand described in 'Demand Forecasting Methodology Main Report Joint R&D WR-01/A' Pages 15-19), such that;

Figure 5.15: Consumption, customer supply pipe leakage, and plumbing losses; included in leakage (blue) or customer consumption (green) - (not to scale)

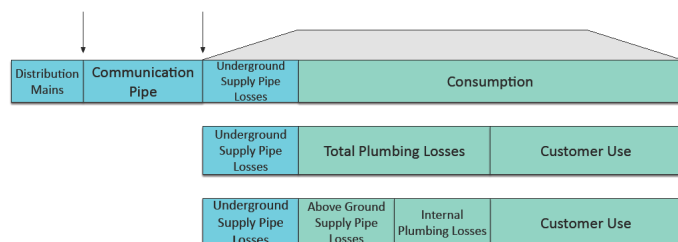

Both the leakage programme and smart metering programmes, will have an effect in reducing;

- Leakage distribution losses,
- Customer supply pipe leakage and,
- Internal 'plumbing losses'

Consequently, the impact of this, will by definition, be attributed to:

- Customer consumption savings will include reductions in internal plumbing losses and above ground customer supply pipe leakage (cspl). This will affect our Per capita Consumption target.
- Leakage savings will include reductions in distribution losses, communication pipe losses and underground supply pipe leakage losses. This will affect our Leakage target.

Table 5.3: Savings from our programmes attributed to leakage and household consumption

	AMP7	AMP8	AMP9	AMP10	AMP11
Average annual savings Attributed to Leakage					
Leakage Distribution Loss saving (Ml/d)	14.01	23.35	23.74	29.38	42.14
Smart Metering Distribution Loss saving (Ml/d)	0.68	4.60	6.53	6.51	6.49
Smart Metering CSPL saving (Ml/d)	5.98	15.19	19.71	20.77	21.72
Annual average savings attributed to the Customer					
Water Efficiency - Toilet rebate (plumbing Loss) (Ml/d)	0.90	4.60	10.74	16.55	19.89
Water Efficiency - Leaky loos campaign (plumbing Loss) (Ml/d)	2.21	4.39	4.96	5.26	5.50

Figure 5.16: Distribution loss, cspl and plumbing loss savings as attributed to our leakage (purple) and household consumption (blue)

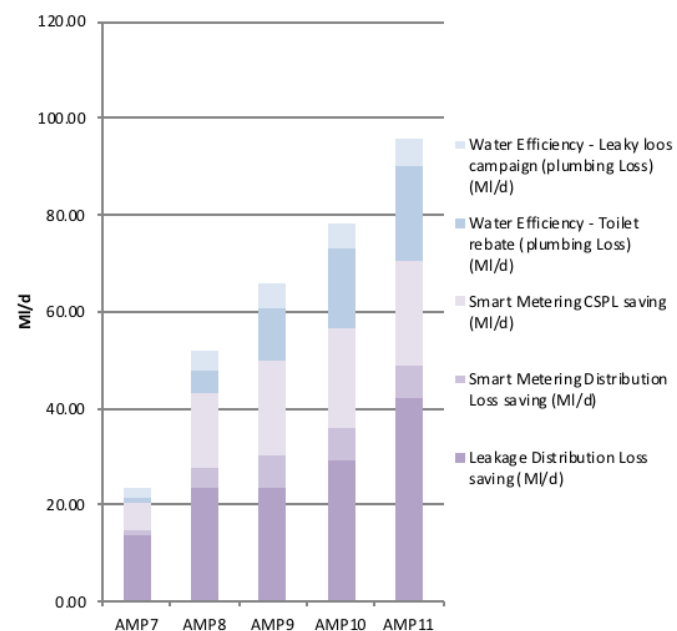

These external (distribution loss and external cspl) and internal leakage (plumbing loss and leaky loo) reductions will form the most significant part of our anticipated demand reductions over the WRMP plan period.

5.2.16 Smart metering and leaky loo case study

Anglian Water installed a smart meter on the customer's supply in November 2016. Nearly a year later, the customer's consumption was suddenly noted to have significantly increased.

This could be seen in the real time flow of hourly data from the smart meter (and the assessment of 'night-flow' readings which should normally be near zero or very low).

Anglian Water was able to alert and visit the customer within days of the leak. During the visit, it was found that the dual flush toilet had developed a fault. With the customer's permission, Anglian Water temporarily reduced the waste flow, and the customer repaired the fault that day.

Unchecked, the leaky loo would have increased the customer's bill by £160 per month. Not only was this speedily resolved, but the data allowed Anglian Water to calculate the cost to the customer of the wasted water, and refund this on the customer's next bill.

"The Anglian Water Representative was extremely helpful, as well as concerned with our leakage problem. Excellent customer service!"



Evidence of Anglian Water's intervention can be clearly seen in the smart meter data above, which shows average hourly consumption each day before, during, and after the leak had occurred.

Correcting this leak saved over 500m³, which would have been lost if this had only been detected based upon a manual read.

The availability of this data is key to our ability to flag these issues and assist customers in their rectification.

Numerous examples are available showing the potential for smart meters to allow us to help identify these leaks and assist customers in their correction.

Monitoring data at the individual, local and regional level will be a constant process, enabling us to determine the success of the programme and tailor our engagement to local demographic conditions.

5.3 Leakage Reduction

Our ambition for leakage

Leakage is a particular concern for our customers, who see it as wasteful and a sign that we are not 'doing our bit' to conserve water and invest in infrastructure. This can be a strong disincentive to customers adopting more water efficient behaviours and customers often associated leaks with service interruptions.

Our leakage performance leads the industry.

We have cut leakage by more than a third since privatisation in 1989 and it is now at record low levels; around half the national average based on the amount of water lost per kilometre of main.

Our three-year average has continued to fall from 191MI/d at the start of the AMP.

- In 2016/17 we achieved 184.72 MI/d, and
- In 2017/18 and we recorded a leakage level of 182.66MI/d

Thus, we are taking significant steps towards our AMP6 target of 172MI/d in 2019/20 (with a three year rolling average of 177MI/d). Over AMP6 we will invest £124 million in people and in state-of-the-art technologies to drive leakage even lower.

Currently we are ahead of Ofwat's target level of 192MI/d.

However, we do not believe it is good enough to stop at the targets set by our regulator, especially when reducing leakage is such an important issue for our customers and so vital for us in this dry part of the country.

Consequently, we are setting a more ambitious target of reducing leakage by 30MI/d by 2025.

Thus, we aim to reach a leakage level of 142MI/d by 2025, a reduction of 22% from 2017/18, and further to achieve 106MI/d of leakage by 2045, a reduction of 38% from the 2020 baseline. Leakage will reduce from the current level of 16.7% of distribution input (DI) to less than 10% of DI by 2045.

To achieve our ambition we will need to use innovative techniques, as well as tried and tested methods. These include a mix of well understood interventions and others that are more innovative.

Additionally, in the future, smart metering offers an opportunity for a step change in detecting customer supply pipe and plumbing leaks by improving our understanding of continuous flows into customer properties (usually indicating a leak), as well as increasing our overall understanding of the network.

5.3.1 Background

Leakage is treated RAW water lost from our distribution system. It includes water lost from our mains and pipe networks (known as distribution losses) and losses from customers' supply pipes (known as customer supply pipe leakage, CSPL).

Our record in leakage reduction has improved dramatically in the last 20 years and we are currently a 'frontier' company, within the industry. We now lose 21% less water through leaks than we did in 1998, despite the expansion of our pipe networks to connect to over 500,000 more properties.

In AMP6 we set ourselves a stretching target of reducing leakage to a three year average of 177 MI/d by 2020. This leakage target is beyond the 'Committed Performance Level' (CPL). This CPL is supported by an Output Delivery Incentive (ODI). Our AMP6 leakage ODI uses a three year rolling average to measure performance against the Ofwat AMP6 target of 192 MI/d. The leakage ODI is the mechanism through which we recover the investment needed to

achieve a 20 MI/d reduction in leakage compared to the CPL.

Our AMP6 target is below the level suggested by the Sustainable Economic Level of Leakage (SELL) methodology. A key reason for setting a target beyond the level suggested by the SELL is that leakage is one of the most important issues for our customers. Through our PR14 customer engagement activities, customers told us:

- Fixing leaks was a top priority for additional investment
- Tackling leaks was a core service, and,
- Fixing leaks was an important element in delivering a value for money service.

2017-18 saw us continue our industry-leading performance on leakage; we achieved 182.66 MI/d, which is 29 MI/d lower than our AMP5 SELL target of 211 MI/d (equivalent to the demand from approximately 100,000 new homes).

Figure 5.17: Water company leakage performance in 2016-17 (data from Discover Water)

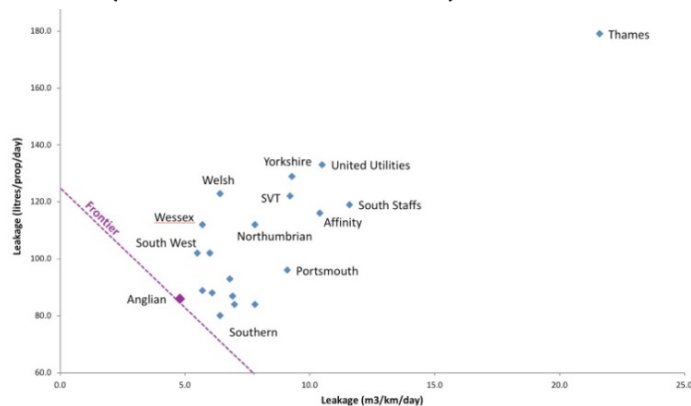

5.3.2 Current methodologies

The main parts of our strategy can be summarised:

- **Optimised Water Networks**, in which bursts are prevented through better management of pressure in the pipes. The approach aims to deliver a 'calm' network that provides a reliable and resilient service through a reduction in leaks, low pressure and interruptions to supply, while improving serviceability and water quality. In the first two years of AMP6, OVN has been responsible for a reduction of just over 6.27MI/d in leakage across the region. Work has been going on in Peterborough since 2013, with large pressure-reducing valves and major cross connections allowing us to manage the pressure of water supplied to 92 per cent of properties. Similar schemes were completed in Bury St Edmunds and Bedford and in Milton Keynes, Lincoln and Ely in 2017/18.
- **Intensive Leakage Detection** teams that track down hard-to-find leaks and target areas with ageing pipes. We have delivery teams split across three regional areas, a central control team and an engineering design and delivery team. These teams have the mandate, training and equipment to track down hard-to-find leaks and to pro-actively target areas where we believe pipes may be coming to the end of their useful life. This year, the teams saved a total of 3.75MI/d.
- **An Integrated Leakage and Pressure Management system** to bring together network information, making it easier to control leakage and target work. New and enhanced tools further improve our ability to target work at areas of the network with rising leakage and to plan our detection teams' activities.

- **Improved and extended metering** across our network, including our raw water network and at reservoirs to help us to understand where leakage is occurring and take action to stop it
- **A reduction in customer supply pipe leakage** (cspL) that will be facilitated by smart meters

5.3.3 Looking to the future

We continue to believe that minimising the amount of water we lose from our system through leakage is the right thing to do for our customers and the environment.

Our ambition to reduce leakage is supported by the UK government and Ofwat. Ofwat's draft methodology for the next price review, PR19, contains a stretching target for companies to reduce leakage by 15%.

In accordance with this we have set ourselves a challenging new target for leakage, notwithstanding our already industry leading performance.

Thus, we aim to reach a leakage level of 142MI/d by 2025, a reduction of 17% from the 2020 baseline.

To achieve our ambition we will need to use innovative techniques, as well as tried and tested methods. We will continue to explore new solutions and operational practises to reduce leakage. The sub-options we have identified not only address the symptoms of leakage, but activities like pressure management also allow us to take action to prevent leakage occurring in the first place.

As part of our demand management strategy we have considered six direct leakage reduction sub-options and six sub-options for activities that enable, support and sustain further leakage reduction. These include a mix of well understood interventions and others that are more innovative.

We are actively exploring how the use of state-of-the-art technology can help us to achieve further reductions, and that is why we have made 'zero leakage and bursts' one of the seven goals of our Shop Window initiative²⁹ and we are actively trialing technologies such as thermal imaging drones to detect leaking pipes.

Additionally, in the future, smart metering offers an opportunity for a significant advance in detecting leaks by improving our understanding of continuous flows into customer properties (usually indicating

²⁹ For the last year, Newmarket in Suffolk has been the location for our Innovation Shop Window. Within this area we showcase the combined effect of existing and future innovation, to show in microcosm what a 21st century water company could look like.

a leak). The benefits of leak detection associated with smart metering are included within the metering business case. In addition, live data for actual consumption will make the identification of network leakage more accurate by measuring the actual difference between bulk (district) meters and customer use. This benefit is captured in the metering cost benefit analysis.

Figure 5.18: Leakage savings over the WRMP period (including those attributable to smart metering)

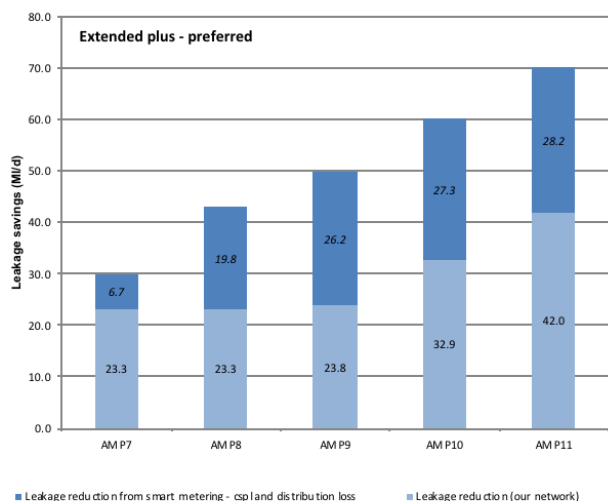

Thus, building on our current position, leakage will reduce from the current position, representing 16% of water put into distribution (Distribution input (DI)) to less than 10% by 2045.

Figure 5.19: Leakage as a percentage of distribution input (demand)

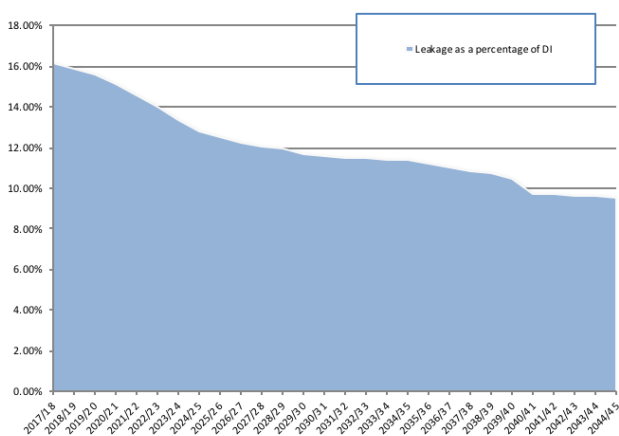

5.3.4 Targeting leakage reduction

Leakage option development and targeting has been analysed at the District Metering Area level (DMA), with leakage levels being characterised, in order to understand how further leakage investigation and analysis might be applied and which solutions might be best adopted across the region.

The DMAs have been characterised;

- F - requiring further investigation
- G - Good, low leakage areas
- H - High leakage areas
- R - Recurrent leakage areas

Figure 5.20: Map showing high/low/recurrent leakage areas by DMA

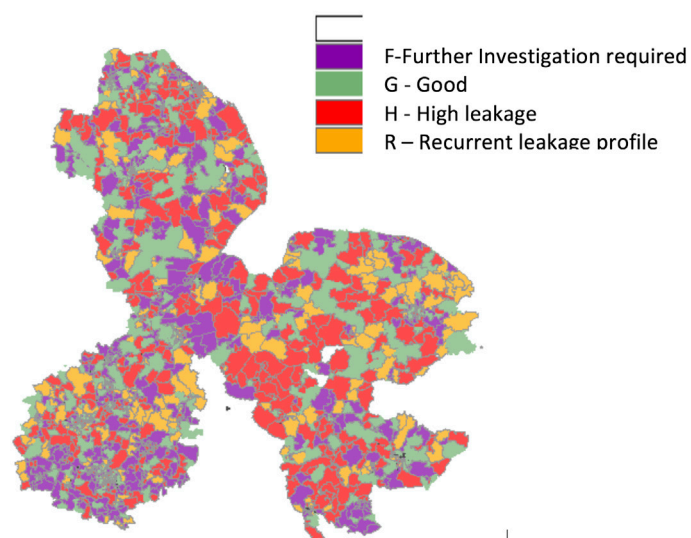

Further work has then been carried out to align the targeted leakage options with the overall WRZ risk assessment.

The costs associated with the “Extended Plus” leakage reduction programmes (excluding those associated with smart metering) can be shown, as below;

Table 5.4: Preferred Extended Plus leakage programme and costs. (note this excludes leakage savings from smart metering)

	Cost (AMP7)	Saving (AMP7)	Cost (AMP11)	Saving (AMP11)
Total financial (pre financing)	£72m	23.3 MI/d	£282m	42.0 MI/d
Total financial (with financing)	£77m		£344m	

5.4 Water Efficiency

Encouraging changes in behaviour

An important part of managing demand is empowering customers to control and reduce their water usage. This involves encouraging customers to use less of our retail product - a concept that some may find surprising! We have a dedicated water efficiency team that leads our work in this area and carries out our communications.

Key to our water efficiency work are our 'Bits and Bobs' audits and home visits. These visits aim to deliver water savings through retrofitting free water saving devices and, through the provision of advice, to encourage positive behaviour change.

As well as 'Bits and Bobs', we are continuing to run our 'Drop 20' campaign. 'Drop 20' is a water efficiency campaign which we developed in response to the 2011-12 drought and we continue to offer it to customers when they request a meter.

We are also working on the next iteration of our engagement with business water Retailers regarding demand management. This will include a dedicated section on our Wholesale website providing targeted information for Retailers and also content which can be directed towards their non-household customers.

Looking to the future

Our water efficiency campaign is running successfully in AMP6. We are keen to build on this momentum and expand these activities in the future. Our proposed packages represent our most extensive programme of water efficiency and behaviour change activity to date.

Our ability to change customer behaviour and drive efficiency could see a noticeable improvement, if it is supported by smart metering options (as described in the metering section). Smart metering will enable innovative water efficiency interventions and provide a platform for tailored customer engagement. Some of the options that are enabled by smart metering include customer campaigns and reward schemes through the smart meter usage portal and smart home device retrofitting.

The success of smart metering will also be influenced by our water efficiency activities.

We understand that smart metering is a technological revolution and it will need to be accompanied by a behavioural revolution to unlock its full potential to help manage demand.

We are excited by the opportunities that the provision of timely consumption data from smart metering could have on our ability to change consumer behaviour and promote conservation of water.

5.4.1 Continuing engagement

We assess our success in encouraging water efficient behaviour by measuring average water consumption per-property. This is one of our ODIs. Our target is to reduce average consumption by 7 litres per household per day (l/household/d), from 312 l/household/d to 305 l/household/d in AMP6. We have not developed an ODI for the numbers of meters installed or water efficiency audits conducted, because it is the actual water savings achieved by these and other activities that is significant.

There is a strong link between our work to address water affordability in our region and our water efficiency and metering activities. The provision of water efficiency advice to metered customers helps them reduce consumption and consequently their bill. Because of this, we coordinate our metering and water efficiency work to support customers and

encourage them to reduce their water consumption. Our combined metering and water efficiency programme divides the region into areas that are visited in turn, combining the offerings from all elements of the programme delivered in the same place at the same time.

We also believe that there are significant opportunities to work with land developers to promote sustainable developments and water efficient housing.

Additionally we have been liaising with Local Authorities to encourage developers to meet much more stringent water efficiency standards for new developments. With regard to this, Local Authorities have been pushing housing developers to build homes to a standard of 110 litres per person per day.

Ahead of the next AMP we are planning to go further. From 1 April 2018 we are planning to offer developers an incentive to build homes to a standard of 100 litres per person per day as part of the charges they pay to connect homes to our network.

As part of our vision for a sustainable future we are also focused on promoting our 'green' water initiative (Green water being designated as non-potable rainwater, storm-water, or recycled water). This involves, both the promotion of simple solutions (such as water butts to collect rainwater) and liaising with developers to install more complex 'green' water systems into new homes.

5.4.2 Our preferred 'Extended Plus' option

Our strategy includes a range of household water efficiency and behavioural change activities.

Some of these are based upon the continuation of our current activities, such as the 'Bits and Bobs' campaign (where we carry out free water saving home visits and install water saving devices), our retrofitting programme and 'The Potting Shed' (where we provide water efficiency advice and free products to gardeners).

Our preferred option also includes a significant number of new activities, such as incentives for customers to replace leaky toilets with more efficient brands and the installation of water butts.

Additionally our programme for helping to identify 'leaky loos' and providing rebates to customers for toilet replacement will be important in helping customers improve efficiency, while tackling plumbing losses. Our experience indicates that these 'leaky loo' water losses can be significant (500 litres per day) adding to customer bills, whilst undetected.

Further initiatives will draw upon insights from behavioural economics³⁰ and will be enabled by smart metering and our online platform, such as a reward schemes that incentivise water savings.

The assumptions, costs and benefits have been developed using our internal analysis and external experience, whilst understanding the interconnected nature of the programmes (especially with smart metering)

The selected option package will include the following sub-options:

In addition to the baseline activity:

- Multi-utility consumption portal
- Leaky Loos campaign

- A rewards scheme for customers who sign-up on the portal
- A base "Bits and Bobs" campaign (up to 15,000 audits)
- Free installation of water butts (when purchased by a customer)
- Provide and install water butts to certain customers
- Rebate to replace old toilets and a campaign that incentivises customers to replace leaky toilets with A-rated water efficient brands.
- Retrofit 'smart devices' (such as taps) that will send data to the customer portal.

Figure 5.21: Water efficiency savings over the WRMP period.

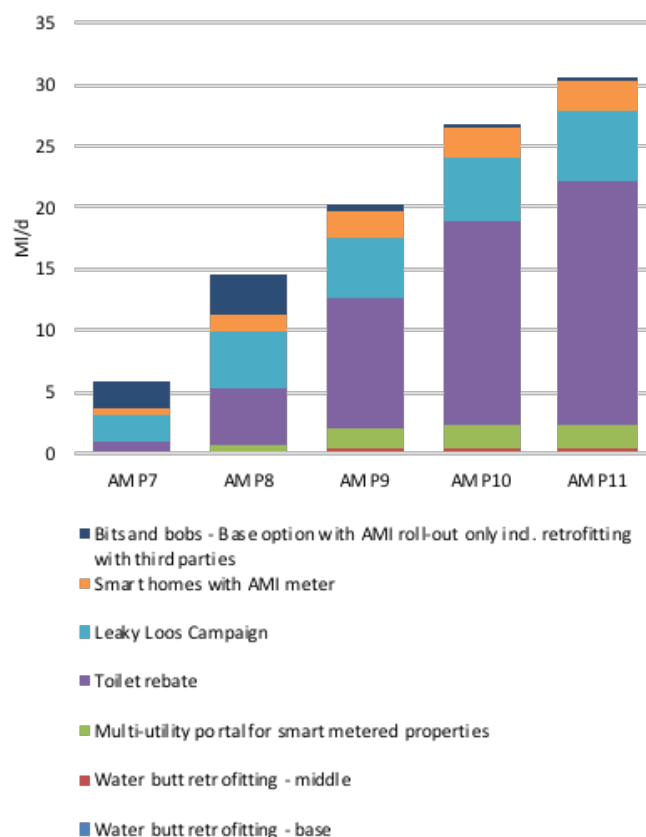

5.4.3 Local Authorities, developers and design standards

We also intend to work collaboratively with developers and local authorities in order to ensure new housing developments are as water-efficient as possible.

To assist with this we will liaise on the development of a blueprint for water efficient gardens, and update

³⁰ Behavioural economics is a method of economic analysis that applies psychological insights into human behaviour to explain economic decision-making.

our Water Calculator (showing methods of meeting per capita consumption (PCC) standards of 110 l/h/d and 80 l/h/d).

We have also investigated trialling alternative water re-use solutions at a development scale (grey-water and rainwater harvesting technology) in order to achieve 80 l/h/d potable consumption.

Additionally, we have been liaising with local authorities in order to revise water building standards to reflect the risks within our region.

We will actively support the development of Local Plan policies which require higher water efficiency standard as a means to reduce demand (110 litres/head/day) and keep track of current standards across the region.

Figure 5.22: Local Authorities adopting higher water efficiency standards - 110l/h/d (July 2018)

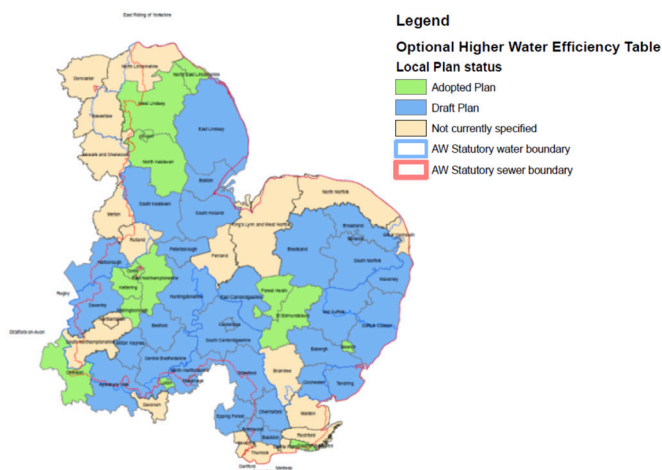

5.4.4 Water efficiency, business customers and 'Retail' separation

As a part of the WRMP Pre-consultation process we engaged with non-household, business, retailers, with regard to non-household water efficiency measures.

Our relationship with our new Retailer Customer base is currently in development, since the market has been opened in April 2017.

However, we are continuing to pursue these relationships which include working with Retailers on operational matters, water demand and drought.

We have engaged directly with each individual Retailer and provided an awareness of where we hold relevant information in our plans and specific characteristics of our region.

Each Retailer has a dedicated 'Wholesale Account Manager' and water efficiency is now a standing item on the agenda, reflecting our keenness to engage

on innovative ways of collaboration, to ensure the efficient use of water.

In addition, we have launched our shop window project in Newmarket, which includes Retailers on our water efficiency efforts in this particular area. Retailers have been provided with direct access to the project manager and, in turn, Retailers have been supportive of our engagement directly with their end user customers in this area. A number of Retailers have shown a considerable appetite to do more and go further.

We are currently working on the next iteration of our engagement with Retailers on demand management, which is in the early stages of development. This will include a dedicated section on our Wholesale website providing targeted information for Retailers and, also, content which can be directed towards their end user non-household customers.

In recognising that the Retailer owns the relationship with the end-user non-household Customer and that they will, in most case, have a greater understanding of water consumption for their customers, we have a scheme which seeks to work with Retailers in helping us manage demand and optimise our network. This is advertised on our Wholesale website.

5.4.5 A behavioural revolution

It is important to note that all of the strategic options include AMI smart metering.

Our water efficiency activity will seek to begin and sustain a behavioural revolution to support the technological revolution that the smart meters represent.

Our ability to show customers their water use, in near real-time, will allow a significant improvement in customer understanding of their consumption, allowing us to tailor water efficiency initiatives directly to our customers.

The research clearly shows that some of the most effective behavioural interventions are supported by consumption information. We believe that the smart metering linked to our water efficiency sub-options represents an opportunity to drive a further advance in demand management and water conservation.

Many of our water efficiency sub-options will be facilitated and enabled by the smart metering campaign, particularly those that involve use of the customer portal.

In the absence of smart metering, our focus for water efficiency would be on our 'Bits and Bobs' audits.

6. Options Considered (and rationale for selection)

The development and selection of our options

In the development of draft WRMP 2019, we have sought to develop an ambitious integrated, multi-AMP demand management strategy that:

- Recognises the value of demand management to our customers and the environment
- Develops demand management programmes holistically
- Recognises the role demand management can play in managing future uncertainty, and,
- Challenges us and our customers to push the boundaries of what is achievable.

In order to develop this ambitious plan, we initially began by reviewing an extensive set of options, drawing on a wide range of sources. These options included;

- Multiple interventions to reduce leakage
- Alternative methods and time-scales for implementing a smart metering strategy
- A wide variety of water efficiency programmes

We reviewed these interventions to develop a shortlist of feasible options.

There are significant synergies between leakage reduction, smart metering and water efficiency activities.

Given these synergies, it was essential to consider demand management programmes holistically through the development of 'strategic options'.

Consequently the feasible elements selected for demand management were packaged into these 'high', 'medium' and 'low' 'strategic' options for further analysis. Thus, our three strategic demand management options each consist of a combination of smart metering, leakage reduction and water efficiency activity.

Each option has been built from the bottom-up by combining water resource zone sub-options.

Decisions regarding the geographical focus of each strategic option were informed by a risk assessment including the 'Draft Problem Characterisation' scores, current levels of leakage and metering, and the practicalities of implementation.

6.1 Developing the options list

We have a strong track record delivering demand management. Our success, however, means that there is limited potential to achieve further savings through tried and tested demand management activities as these have effectively been 'locked-in'. The next step-change in demand management will be achieved through technological innovation (such as smart metering) and initiatives that are relatively untested in a UK context.

In order to consider the widest possible range of options, we developed and reviewed an unconstrained list of options that drew on:

- Our current business practises and how we could improve them
- Current practises and plans of other UK water companies

- Practises in other sectors (e.g. gas and electricity) to encourage demand management and behaviour change
- Practises in other countries or localities that experience water stress
- Opportunities provided by technology and innovation, and,
- Latest academic research.

This process identified options such as;

- The use of rewards and competitions to incentivise behaviour change, and
- Development scale grey water reuse systems to reduce potable consumption to 80 l/head/d.

It also included an option to install smart meters, (specifically Advanced Meter Infrastructure (AMI) technologies).

Smart meters offer the opportunity to collect significantly more consumer consumption data than dumb meters (which are currently read annually or bi-annually). They transmit readings every hour over a fixed, long-range radio network. This data will then be provided to customers over a dedicated website or 'customer portal'.

6.2 Screening the unconstrained list

We then assessed the unconstrained list to identify feasible option-types using the screening criteria set out in WR27 Water resources tools (UKWIR, 2012). As a result of this process, a number of option-types were screened out. The options we have screened out and our reasoning are described below.

6.3 Developing strategic options

Using the remaining options on the 'short-list', we undertook a 'process of definition' in order to develop the detail of each option (for example, for smart metering options this included roll-out trajectories, meter technology selection, customer interaction and supporting technologies), to understand dependencies and exclusivities, and to create options that are specific to WRZs.

There are significant synergies between leakage reduction, smart metering and water efficiency activities. For example, before we can ask our customers to conserve water resources we must show that we are 'doing our bit', particularly by reducing leakage and fixing visible leaks as quickly as possible.

The frequent meter readings and abundance of data provided by smart meters will allow us to identify customer supply pipe leakage (cspl) and internal plumbing losses (leaky loos) and then to proactively contact customers so that they can repair those leaks.

Smart metering data will also allow us to identify leaks on our network more efficiently. Many potential water efficiency initiatives will be dependent upon the installation of smart meters, including the introduction of targeted behavioural change initiatives, tariffs, and the installation of smart appliances.

Given these synergies, it was essential to consider demand management programmes holistically through the development of 'strategic options'.

Each strategic option includes smart metering, leakage reduction and water efficiency sub-options, and has been built from the bottom-up at the WRZ geographic level.

Decisions regarding the geographical focus of each strategic option were informed by Draft Problem Characterisation scores, growth risks, current levels of leakage and metering, and the practicalities of implementation.

This approach is consistent with the approach to demand management in the Water UK study, Water Resources Long Term Planning Framework (WRLTPF), which developed four demand management scenarios consisting of a combination of leakage, metering and water efficiency initiatives.³¹

The WRLTPF considered four scenarios for demand management by water companies as part of its forecast for demand. These are shown below.

- 'Business as Usual' (BAU) - Base: this represents the situation that would occur if water companies continue with their current policies and methods for reducing demand, but the societal and policy support for demand management is low.
- 'Business as Usual' (BAU) - Upper: as above, but with a greater degree of societal and policy support.
- Extended: this represents an ambitious extension to demand management, incorporating initiatives such as the use of differential tariffs to help reduce demand.
- Enhanced: this represents a significant advance in demand management, incorporating initiatives such as grey water re-use and much tighter controls on water efficient design for new households.

Reflecting this guidance, we produced a number of variations of the strategic options, including complementary elements of leakage, smart metering and water efficiency interventions for evaluation.

Baseline

- Maintaining leakage at the current level (177 MI/d - 3 year rolling average)
- Continued 'dumb meter' roll-out to maximum feasible penetration (95%)
- Continuing current water efficiency strategies.

³¹ <http://www.water.org.uk/water-resources-long-term-planning-framework>

Extended

- Reduction of leakage by 38MI/d to 134MI/d by 2045, by a combination of leakage and smart metering strategies. This does not meet our 15% reduction target.
- Implementation of smart metering over a 3AMP (15 year) programme to maximum feasible penetration (95%)
- 'Extended' programme of water efficiency strategies.
- Total Option savings
 - End of AMP7: 26MI/d
 - End of AMP11: 71MI/d

Figure 6.1: Water savings for the 'Extended' option

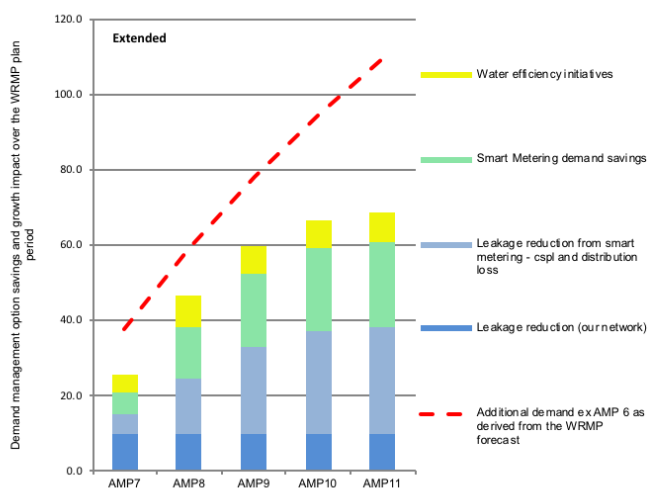

Extended Plus

- Reduction of leakage by 70MI/d to 106MI/d by 2045, by a combination of leakage and smart metering strategies.
- Leakage reducing by 21% to 142MI/d by 2025 and by 42% to 106MI/d from the current value (182.66MI/d)
- Note leakage currently represents 16% of Distribution input and will represent 9.5% of DI in 2045.
- Implementation of smart metering over a 2AMP (10 year) programme to maximum feasible penetration (95%)
- 'Extended Plus' programme water efficiency strategies
- Total Option savings
 - End of AMP7: 43MI/d
 - End of AMP11: 123MI/d

Figure 6.2: Water savings for the 'Extended Plus' preferred option

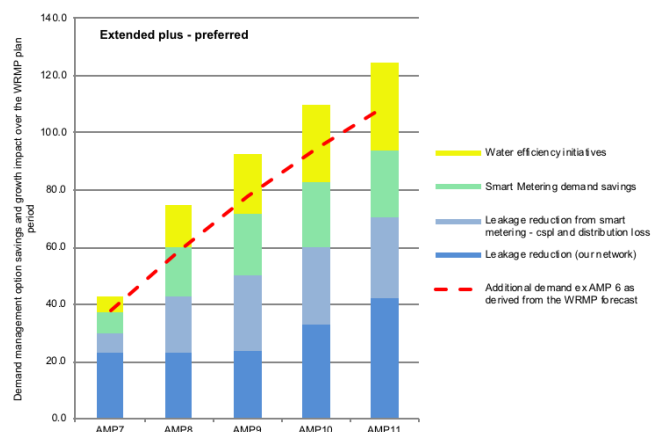

Aspirational

- Reduction of leakage by 105MI/d to 72MI/d by 2045, by a combination of leakage and smart metering strategies
- Implementation of smart metering over a 2AMP (10 year) programme to maximum feasible penetration (95%)
- 'Aspirational' programme water efficiency strategies
- Total Option savings;
 - End of AMP7: 60MI/d
 - End of AMP11: 164MI/d

Figure 6.3: Water savings for the 'Aspirational' option

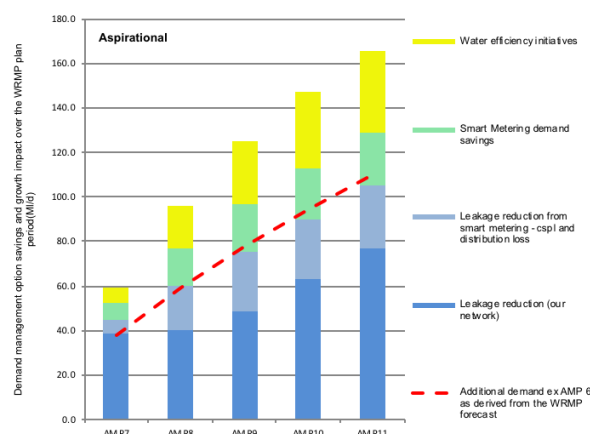

6.4 The strategic options

The three strategic options are outlined in the table below.

Table 6.1: The strategic demand management options

	Baseline	Extended	Extended plus	Aspirational
Metering	No additional smart metering - dumb meter only	3 AMP AMI roll-out 15 Year roll-out to practical limit of meter penetration 50MI/d savings in 2045 including; 22MI/d savings from behavioural change 22MI/d cspl savings, 6MI/d distribution loss savings	2 AMP AMI roll-out 10 Year roll-out to practical limit of meter penetration 51MI/d savings in 2045 including; 23MI/d savings from behavioural change 22MI/d cspl savings, 6MI/d distribution loss savings	2 AMP AMI roll-out 10 Year roll-out to practical limit of meter penetration 51MI/d savings in 2045 including; 23MI/d savings from behavioural change 22MI/d cspl savings, 6MI/d distribution loss savings
Leakage reduction	Leakage held at 172 MI/d (the AMP 6 company commitment)	10 MI/d reduction by 2045 (excludes 28 MI/d cspl and distribution loss reductions from smart metering programme - see above)	42 MI/d reduction by 2045 (excludes 28 MI/d cspl and distribution loss reductions from smart metering programme - see above)	77 MI/d reduction by 2045 (excludes 28 MI/d cspl and distribution loss reductions from smart metering programme - see above)
Water efficiency - household	Continuation of current activity, including: The Potting Shed initiative Communications campaigns on discretionary use including events, education, and use of Broadcast Beacons	Leaky Loos campaign A rewards scheme for customers who sign-up on the portal A base Bits and Bobs campaign (up to 15,000 audits) Free installation of water butts (when purchased by a customer) 8MI/d savings by 2045	In addition to the Extended option: Multi-utility consumption portal ³² Provide and install water butts to certain customers Rebate to replace old toilets Retrofit 'smart devices' (such as taps) that can send data to the customer portal 32MI/d savings by 2045	In addition to the Extended Plus option: Provide and install water butts to all customers Use satellite technology to advise customer when to water their gardens 38MI/d savings by 2045

³² The multi-utility portal will be trialled in Newmarket during AMP7, then rolled out to all WRZs from AMP8.

6.4.1 Demand Management Options and WRZ Targeting

During the demand management options appraisal process, consideration has been given regarding the way in which the options should be implemented across the AWS region.

Demand management options should be targeted and prioritised, based upon a variety of metrics which might impact the implementation of the options.

Current and forecast metrics should inform the prioritisation of the options (metering, leakage and efficiency / behaviour) and will offer different perspectives in assessing how options might be rolled out across the AWS region.

Option targeting and prioritisation should be directed at WRZs/PZs based upon identified:

- Forecast WRZ risks and issues
- Opportunities based upon current WRZ status
- Potential barriers (technological) to option development (geographic implications - household distribution/density)

6.4.2 WRZ Combined Ranking Assessment - Risks/ Opportunities/Barriers

Water Resource Zones (WRZs) were originally analysed and ranked according to a variety of metrics, which might influence future demand management options and their implementation.

These included:

- Household Growth impacts 2020-2045 (Combined actual and % change, in order to account for the differential in WRZ size)
- Current Leakage (Actual) Ranking (2015/16)
- Supply Demand - Provisional Deficit Ranking (2015/16)
- Problem Characterisation - Vulnerability Ranking based on score and near/long term risk assessment
- Ranking assessments based upon current meter penetration

Additional metrics were also considered, including current WRZ per capita consumption (PCC) and household density.

These rankings were then combined to give an overall value (worst to best), in order to provide an initial guide to the potential roll-out programme, (note these were subsequently, modified to also reflect detailed operational considerations).

The risks associated with each category can be quantified and visualised graphically, highlighting which risks predominate in each WRZ and overall, which WRZs have the smallest and largest risk values. When combined this produces the 'spider-graph' as shown, which can be disassociated to also show the WRZs individually.

Figure 6.4: Pyramid graph showing combined risks for each WRZ

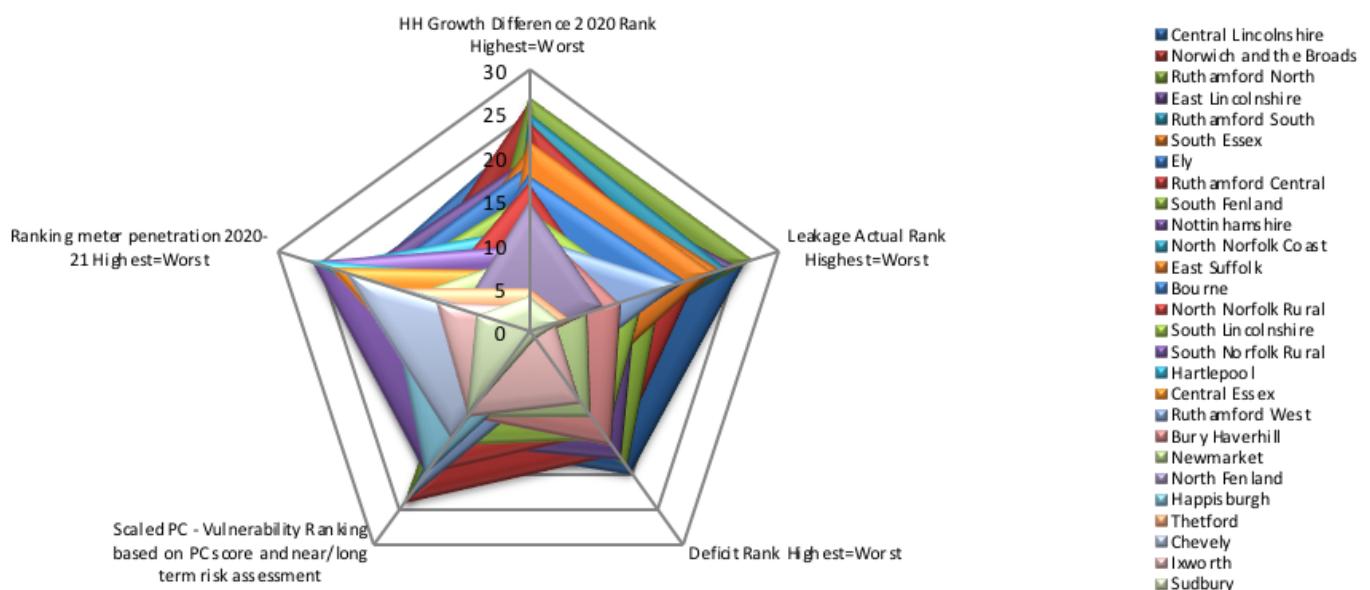

6.4.3 Impact of climate change on each preferred (final plan) demand options

Overview

To forecast the impact of climate change on household demand, annual percentage change factors, developed by UKWIR (2013) 'CL04B impact of CC on water demand', have been used. It is noted that, UKWIR (2013) found no consistent weather-demand relationship for non-household demand; consequently, following guidance no climate change allowances have been made. The 'regional tables' provided by UKWIR (2013) detail three demand criteria: annual average, minimum deployable output,

and critical period. The 50th percentile annual average factors have been used for the Dry Year Annual Average (DYAA) planning scenario (0.73% in the year 2044/45). The 50th percentile critical period factors were used for the Critical Period (DYCP) planning scenario (1.43% in the year 2044/45).

Climate change factors have been determined:

Table 6.2: Climate change factors (%)

	2024/2025	2029/2030	2034/2035	2039/2040	2044/2045
Dry year annual average (DYAA) Forecast	0.09	0.19	0.33	0.51	0.73
Critical period (DYCP)	0.17	0.37	0.65	1.00	1.43

The demand forecast has been determined, whilst applying these factors, with demand management savings then subtracted from the calculated DI. With regard to the sensitivity of demand options (as delineated in the WRMP tables) to climate

change, we have considered there to be a marginal effect. However, we would expect that Behaviour and Efficiency Measures would be adapted and potentially extended to deal with any extreme weather events related to climate change.

Table 6.3: Climate change sensitivity of demand management options

	Climate Change Sensitivity
Leakage DMO - Distribution Loss Saving (RTN_WSM1) DMO - Leakage - Distribution Loss Saving (RTN_LKG1)	<ul style="list-style-type: none"> Climate change is considered to have minimal influence on Leakage detection (noise logging etc.) Leakage repair might be influenced to an extent by more extreme weather events. Effects are considered not to be significant to be quantifiable or reduce the DMO savings.
Smart Metering DMO - Measured HH Consumption Saving (RTN_WSM1) DMO - Measured HH CSPL (RTN_WSM1)	<ul style="list-style-type: none"> Climate change is considered to have no effect on the smart meter roll-out or installation. Climate change is considered to have no effect on the operation of smart meters.
Water Efficiency Measures DMO - Unmeasured Efficiency Saving (RTN_WEF2) DMO - Measured Efficiency Saving (RTN_WEF2)	<ul style="list-style-type: none"> Marginal or no effect expected with respect to the implementation of Behaviour and efficiency measures. Climate change impacts (more extreme weather events) will potentially be mitigated with additional/extended water efficiency programmes/measures.

6.4.4 Metering - Options considered

It is important to note that all of the strategic options include the installation of smart meters across our region, reaching the limit of feasible meter penetration (95%) by the end of AMP9 (in the 'Extended' option) or AMP8 (in the 'Extended Plus' and 'Aspirational' options).

By 'smart meters' we specifically mean Advanced Meter Infrastructure (AMI) meters and their associated transmission networks, with the data provided to customers over a dedicated website or 'customer portal'.

As discussed, we believe that smart meters offer the potential to deliver significant future demand savings, through the innovative methods of customer engagement that will be enabled by the frequent data provided (over and above what they would save with a dumb meter).

Secondly, they make possible a range of future water efficiency initiatives, such as non-price behavioural change incentives, financial incentives, or increasing block tariffs, which can generate further water saving.

In addition, the frequent consumption data that smart meters generate will allow us to unlock a range of additional benefits. For example; a better understanding of demand will allow us to improve the efficiency of our operations through targeted network optimisation.

Finally, smart metering is also an integral part of our strategy to achieve the leakage targets associated with each of the strategic options. Smart metering data will help us to identify leaks on our network which can then be fixed more quickly, saving water.

It will also allow us to identify customer supply pipe leakage and plumbing loss leaks inside the customer's property. Although these leaks are not our legal responsibility to fix, they represent a significant proportion of total water lost through leakage. For example, in 2017/18, CPSL accounted for nearly 25% of our total leakage. Once we have identified these leaks, we will then contact customers proactively and encourage them to fix it.

Automatic meter reading (AMR) meters

AMR is a technology of automatically collecting consumption data and transferring that data to a central database for billing and other purposes. We have been trialling AMR meters in Colchester (2012-2017). During this trial radio meters were installed at 21,000 customer properties and targeted by a 'mobile' network of passive readers. The data is only collected periodically (weekly or bi-weekly).

We have decided not to progress AMR metering following the findings of the AMR trial in Colchester. We equipped around 10 refuse collection lorries operated by Colchester Borough Council with passive readers which 'listened' for the AMR water meters installed at properties on their weekly refuse collection rounds.

Reading yields vary from week to week, but, generally, only around 50% of meters are read every week and 75% read every four weeks.

These results do not give us the confidence that we could use this method of data retrieval for our customers, as it is clear that around a quarter of our customers would miss out altogether on weekly and even monthly reads. We would not be able to meet the customer expectation of a regular and reliable reading.

We would still need to visit the properties to guarantee a billing read, which effectively provides us with no benefit on reducing meter reading costs or carbon. Even if the data were reliable and comprehensive, the data can not be used to track down leaks on the network - a benefit we seek from the hourly smart meter data.

For both these reasons we have discarded this as a viable long term solution.

6.4.5 Smart meter option development

Options for metering were developed with reference to the following key variables:

- The metering trajectories i.e. the number of properties, where meters would be installed split by metering programme (optant metering, selective metering, enhanced metering, proactive replacement, reactive replacement). In addition, the number of new domestic supplies (which will be metered on connection) per year was sourced from the property forecast prepared as part of the WRMP19 process.
- The roll-out pattern and speed. This information was provided as the number of meters to be installed per year per planning zone, as developed in accordance with the WRZ risk assessment.
- The type of meters deployed: dumb or smart;
- The technology used to read meters: manual reading for dumb meters and fixed network for AMI meters; and
- The type of interaction with customers: through customer portal for AMI metered customers.

6.4.6 Smart meter option summary

Five options were developed to support demand reduction under the category of metering. These options are:

1. Business as usual (BAU) metering i.e. continuation of the company's AMP6 programme with the exception of enhanced metering policy.
2. Advanced metering infrastructure (AMI) metering over 3 AMP periods.

Figure 6.5: 'Smart' metering - roll-out projection over 3 AMPs

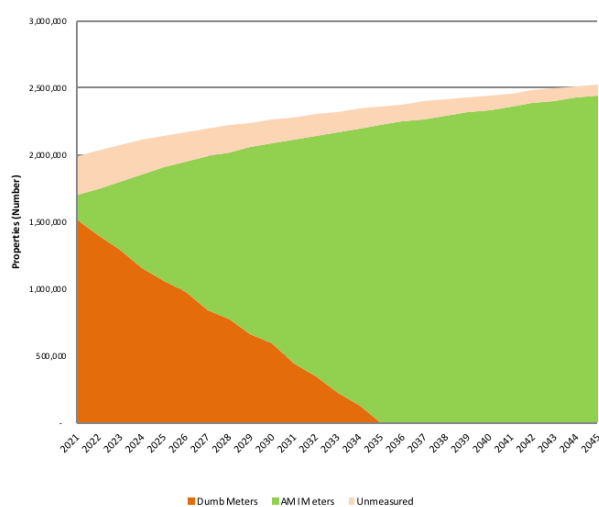

3. AMI metering over 3 AMP periods with a reduced proactive meter replacement programme.
4. AMI metering over 2 AMP periods.

Figure 6.6: Smart' metering - roll-out projection over 2 AMPs

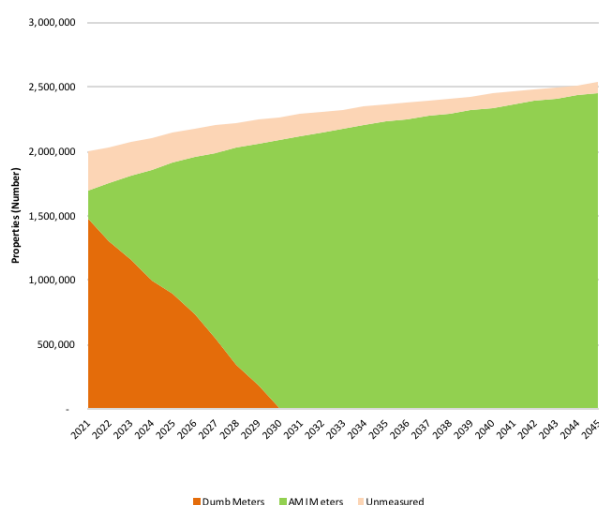

5. AMI metering over 2 AMP periods with a reduced proactive meter replacement programme.

For the purposes of our cost benefit analysis we have assumed that the same or similar technology as is currently being trialled, would be used for the company wide roll-out.

Where it is available, we have used data from the Newmarket trials to inform our analysis. These trials are still on-going with initial results becoming available during 2018.

All smart metering programmes have been designed to reach full household meter penetration and are differentiated by the roll-out duration and therefore speed of installation. The strategies have been built to achieve over 95% coverage; this is considered to be a technically acceptable limit above which the cost of metering the remaining households is disproportionately high (i.e. flats with internal meters).

6.4.7 Meter Roll-out and WRZ targeting

Two options for smart meter roll-out have been considered, 10 year (2AMP) and 15 year (3AMP).

Figure 6.7: Roll-out of smart metering programme across the Anglian Water Region (3 AMP - 15 year)

AMP7 Year 1	AMP8 Year 1	AMP9 Year 1
AMP7 Year 2	AMP8 Year 2	AMP9 Year 2
AMP7 Year 3	AMP8 Year 3	AMP9 Year 3
AMP7 Year 4	AMP8 Year 4	AMP9 Year 4
AMP7 Year 5	AMP8 Year 5	AMP9 Year 5

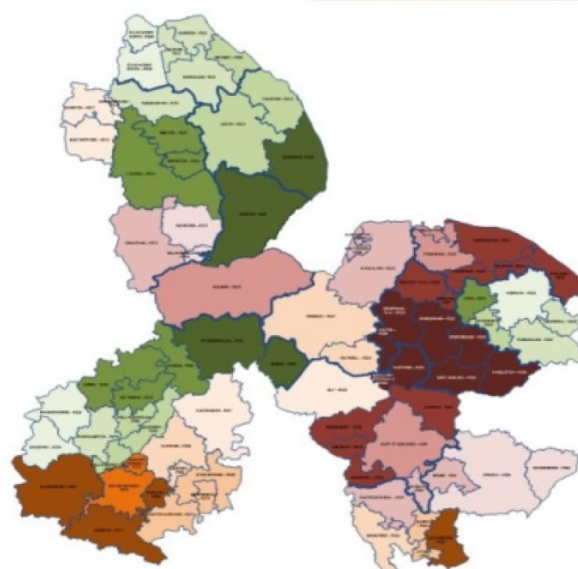
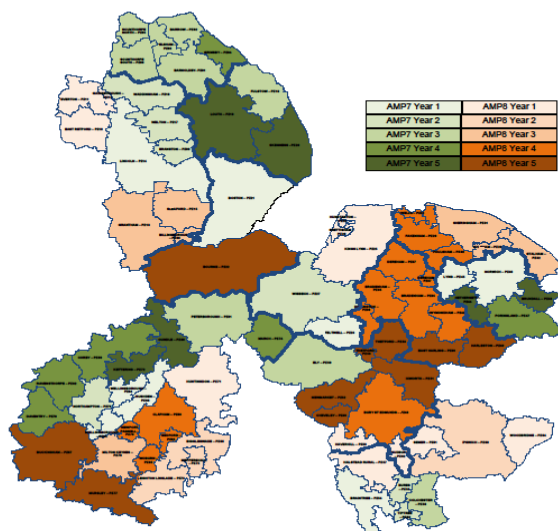

Figure 6.8: Roll-out of smart metering programme across the Anglian Water Region (2 AMP - 10 year)



6.4.8 Comparative costs of metering programmes

Detailed analysis has been carried out with regard to each element of the meter roll-out programme, as both smart meters are introduced and 'dumb' meters continue to be replaced. This will reflect the sequential roll-out of the smart meter programme, WRZ by WRZ over the 10 year 2 AMP preferred plan period.

Thus for each metering programme the following average costs per meter can be determined for AMP 7.

These costs reflect the different metering programmes:

- PMX - Proactive meter replacement of meters as they reach the end of their life, will be a mixture of dumb and smart based on geography.
- AMI Smart meter - Proactive replacement of 'dumb' meters which haven't reached end of life in areas designated for smart meter roll-out; all smart.
- RMX - Reactive replacement of meters. Meters have malfunctioned, will be a mixture of dumb and smart based on geography.
- Enhanced - Company driven meter installation programme in particular areas. Meter is fitted and then customers are encouraged to switch to measured charges. All smart meters
- Meter Options - Customer driven meter installation programme at request of customer, will be a mixture of dumb and smart based on geography.
- Selective - Company driven meter installation

programme at properties where current method of charging is not appropriate (RV no longer valid, unregistered properties); will be a mixture of dumb and smart based on geography.

In addition we have programmed the following types of interventions, associated with smart metering.

- AMI Leak - Company driven programme of leak investigation visits where help customer fix leaks identified through smart meter data. We help identify source of leak in the customer's home or supply pipe, the customer then repairs it.
- AMI Maintenance - Reactive replacement of smart

Table 6.4: Average costs per meter installation for the different meter programmes

Meter Programme	Average cost per meter AMP7
AMI - Smart meter	£108
PMX	£88
RMX	£137
Enhanced	£234
Meter Option	£277
Selective	£333
AMI Leak	£50
AMI Maintenance	£68

points used to provide smart meter data.

Additionally, the meter volumes anticipated for each metering programme for AMP7 can be shown.

Table 6.5: Number of meter installations for each meter programme

Programme Volume	2020/21	2021/22	2022/23	2023/24	2024/25
AMI	108,735	61,782	157,654	145,708	128,501
PMX	125,289	165,756	72,834	88,540	97,284
RMX	17,079	17,079	17,079	17,079	17,079
Enhanced	5,974	1,314	15,436	9,137	1,615
Meter Option	8,203	7,289	6,907	6,087	5,691
Selective	293	261	247	218	204
AMI Maintenance	1,155	1,020	1,339	1,299	1,210

As discussed, the smart meter programme has been designed to be geographically introduced area by area, as the data transmission network is completed. 'Dumb' meters will, therefore, continue to be installed in areas, where the data network has not been installed.

6.4.9 Comparison with the current (baseline) metering programme

The current planned baseline projected installation for meter types can be shown per AMP and cumulatively, for a BAU metering programme.

These can be split into the different metering programmes. Note that the smart metering programme will be rolled out on a Planning Zone by Planning Zone basis (Planning Zones fall within WRZs).

- PMX - Proactive meter replacement of meters as they reach the end of their life (for the smart meter programme this would be a mixture of dumb and smart based on geography).
- RMX - Reactive replacement of meters. Meters have malfunctioned (for the smart meter programme this would be a mixture of dumb and smart based on geography).
- Enhanced - Company driven meter installation programme in selected areas (this would concentrate a co-ordinated installation programme where operations were to be undertaken already or where targeted metering would be beneficial (to help identify leakage/consumption at DMA level)).

Meter is fitted and then customers are encouraged to switch to measured charges (for the smart meter programme this would be all smart based on geography).

- Meter Options - Customer driven meter installation programme at request of customer (for the smart meter programme this would be a mixture of dumb and smart based on geography).
- Selective - Company driven meter installation programme at properties where current method of charging is not appropriate (RV no longer valid, unregistered properties); (for the smart meter programme this would be a mixture of dumb and smart based on geography).

In addition we have modelled the following types of interventions, associated with smart metering.

- AMI Smart meter - Proactive replacement of 'dumb' meters which haven't reached end of life in areas designated for smart meter roll-out; all smart.
- AMI Leak - Company driven programme of leak investigation visits where help customer fix leaks identified through smart meter data. We help identify source of leak in the customer's home or supply pipe, the customer then repairs it.
- AMI Maintenance - Reactive replacement of smart points used to provide smart meter data.

Table 6.6: meter installations per AMP - BAU option

Meter type	AMP7	AMP8	AMP9	AMP10	AM11
Meter Options per AMP	37,516	30,114	24,118	19,316	15,469
New Builds per AMP	177,530	122,722	96,946	83,243	85,790
PMX per AMP	1,152,082	1,024,774	0	1,152,082	1,024,774
Reactive per AMP	85,395	85,395	85,395	85,395	85,395
Selective per AMP	34,848	1,077	863	691	553
Switchers - Move In per AMP	21,248	15,885	11,914	8,935	6,702
Switchers - Opt per AMP	9,345	6,210	4,656	3,492	2,619

Table 6.7 meter installations - cumulative - BAU option

Meter type	AMP7	AMP8	AMP9	AMP10	AM11	% of Total
Meter Options cumulative	37,516	67,630	91,748	111,064	126,533	2.26%
New Builds cumulative	177,530	300,252	397,198	480,441	566,231	10.11%
PMX cumulative	1,152,082	2,176,856	2,176,856	3,328,938	4,353,712	77.71%
Reactive cumulative	85,395	170,790	256,185	341,580	426,975	7.62%
Selective cumulative	34,848	35,925	36,788	37,479	38,032	0.68%
Switchers - Move In cumulative	21,248	37,133	49,046	57,981	64,683	1.15%
Switchers - Opt cumulative	9,345	15,554	20,211	23,703	26,321	0.47%

Costs have been quantified for each of the different meter types.

Table 6.8 Relative cost of meters

Meter Type	Acquisition Cost £/meter
Dumb	£12.70
AMR	£37.00
AMI	£60.02
PMX, internal (AMI uplift)	£22.00
PMX, external (AMI uplift)	£47.50

Figure 6.9 Relative cost of meters

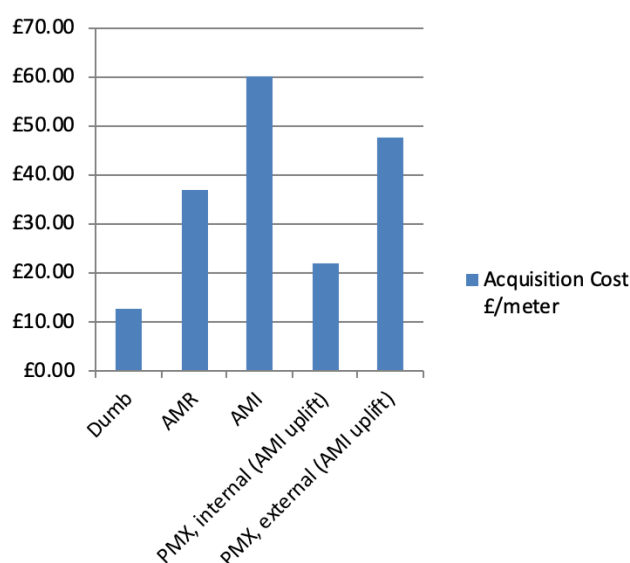

Table 6.8a Meter reading costs

Meter reading cost	
Cost of read - Dumb/AMR HH	£1.37

Operational costs for meter reading for dumb/AMR meters have been quantified, with the average number of meter reads per year for households being 1.033. Thus operation (meter reading) costs can be shown for household meters as follows;

6.4.10 An assessment of the cost-effectiveness of the differing meter types: Compulsory, selective, change of occupancy and optant

With regard to the assessment of alternative metering programmes, note that:

- We have not undertaken a compulsory type programme, because we believe the best method is to use our Enhanced Metering model. In this, we install the meter (to an unmeasured customer) and then engage with the customer, in order to persuade them to switch to measured charging. This has been very successful and has avoided the negative messages associated with compulsory metering. Given our current level of meter penetration any switch to compulsory metering would be expensive (due to the complexities of extending metering to the final most difficult to reach customers) and unpopular with customers.
- We have also used our Enhanced programme in order to change customers to being measured, at the point of a change of occupancy for a property. In this instance, we do not give incoming customer a choice about being billed on measured charges, when they have taken up residence in an unmeasured property with a meter already installed.

- We believe our Enhanced metering model has enabled us to efficiently geographically install meters, allowing us to engage with incumbent occupiers and then should they vacate, allowing us to meter/measure the incoming customer.
- Note that installing the meter at the point of the change of occupancy would be a more random, expensive, process, with the additional difficulty of ensuring that the installation would be complete between tenancies. It would also be difficult to reconcile from a billing perspective.
- We have been actively promoting meter options since the early 1990s. We were the first to offer them for free before this was mandated by Ofwat. We believe this is best method for encouraging the last customers still without a meter.

Note that both our BAU and Smart meter options include 'Selective', 'Change of Occupancy' and 'Optant' programmes.

Note there are relative differences in cost for each of the meter types can be shown as follows. However, it is noted that the overall cost effectiveness of the programmes will be dependent upon the exact volumes of each meter type of installation and their respective locations. Compulsory metering will increase these cost differentials further by targeting 'even harder' to reach customers and metering points.

Table 6.9: Relative cost of meter installation types

Meter type	% Differential in cost from average
Selective	107%
Meter Option	92%
New Supply	121%
Enhanced	86%
Reactive	90%
PMX	104%
AMI Upgrade	104%

Comparing the BAU metering to our preferred 2AMP smart metering roll-out, we have modelled the overall absolute cost/benefit for these scenarios.

Table 6.10: Relative cost of meter installation types

Scenario	Absolute costs/benefits BAU and Preferred option, 2AMP AMI £m / AMP				
	AMP7	AMP8	AMP9	AMP10	AM11
BAU meter installation / replacement	588.4m	591.2m	716.2m	988.2m	1,188.7m
2 AMP Smart meter Installation	738.5m	720.3m	709.2m	1,021.0m	1,215.7m

Based upon the following monetised cost and benefit categories:

Table 6.11: Cost categories - BAU and Smart Meter (including value of water)

Parameter	Type
AMI costs (infrastructure) £/year	Opex
AMI maintenance £/year	Opex
Back-office systems (capex) £/year	Capex
Back-office systems (opex) £/year	Opex
CLST leak investigations £/year	Opex
CSPL leak repair £/year	Opex
Customer contacts £/year	Opex
Customer engagement cost £/year	Opex
Customer portal running cost (opex) £/year	Opex
Customer portal set-up cost (capex) £/year	Capex
HH meter reading (Dumb/AMR) £/year	Opex
L&O monthly read programme £/year	Opex
Meter acquisition costs £/year	Capex
Meter installation £/year	Capex
Meter installation carbon £/year	Opex
Meter reading distance travelled carbon £/year	Opex
Network leakage management £/year	Opex
Replacing MDD and LLU loggers £/year	Opex
Hot water carbon £/year	Opex
Customer use £/year	Value of water
HH CSPL £/year	Value of water
Distribution loss saving £/year	Value of water
Zero Flow Stop detection £/year	Opex

Noting that both smart BAU and smart metering reach the feasible limit for metered/measured customers (approx. 95%) costs and benefits can be compared and an overall cost per MI/d saved can be generated.

Costs for the BAU and smart meter programmes can be shown both per AMP and cumulatively (excluding the value of water):

Table 6.12: Costs (excluding 'value of water') for BAU and Smart Metering

	AMP7	AMP8	AMP9	AMP10	AMP11	Total
BAU Costs (excluding value of water) per AMP -£m	£156.40m	£108.74m	£100.52m	£174.27m	£165.31m	£705.23m
Smart Meter Costs (excluding value of water) per AMP - £m	£313.38m	£262.78m	£131.37m	£251.90m	£244.34m	£1203.76m
BAU Costs (excluding value of water) CUMULATIVE - £m	£156.40m	£265.14m	£365.66m	£539.93m	£705.23m	
Smart Meter Costs (excluding value of water) CUMULATIVE - £m	£313.38m	£576.16m	£707.53m	£959.43m	£1203.76m	

Additionally the water savings that are generated purely by the BAU meter roll-out programme (due to customers being switched from unmeasured to measured charges) and for the additional savings

due to 'smart metering' can be quantified from the WRMP forecast, giving overall costs per MI/d saved. Note that these costs also include PMX (which itself generates no savings under BAU).

Table 6.13: Savings and Cost per MI/d saved shown for BAU and Smart Meter options including PMX

	AMP7	AMP8	AMP9	AMP10	AMP11	Total
BAU Meter Switching Savings per AMP (MI/d)	4.71 MI/d	3.56 MI/d	2.62 MI/d	1.42 MI/d	0.56 MI/d	12.89 MI/d
Smart Meter Additional Savings (MI/d)	22.43 MI/d	23.42 MI/d	3.26 MI/d	1.89 MI/d	1.62 MI/d	52.63 MI/d
Total savings per AMP	27.14 MI/d	26.98 MI/d	5.88 MI/d	3.31 MI/d	2.18 MI/d	65.52 MI/d
BAU Meter Switching Savings cumulative (MI/d)	4.71 MI/d	8.27 MI/d	10.90 MI/d	12.32 MI/d	12.89 MI/d	
Total switcher + Smart Meter Additional Savings cumulative (MI/d)	27.14 MI/d	54.12 MI/d	60.01 MI/d	63.32 MI/d	65.51 MI/d	
Cost per MI/d saved per AMP						Average
BAU Cost per £ m/(MI/d saved)	£33.21m/(MI/d)	£32.04m/(MI/d)	£33.54m/(MI/d)	£43.80m/(MI/d)	£54.69m/(MI/d)	£39.46m/(MI/d)
Smart Meter Cost per £ m/(MI/d saved)	£11.55m/(MI/d)	£10.65m/(MI/d)	£11.79m/(MI/d)	£15.15m/(MI/d)	£18.37m/(MI/d)	£13.50m/(MI/d)

Comparative costs per MI/d saved for each of the differing meter types can also be derived, based upon the expected savings per AMP and the average cost of a meter installation/purchase/meter-read (average for screw-in/ internal/unmade/footpath). This has been calculated using the number of meters required

to achieve a 1 MI/d saving based upon average AMP PCC/PHC/Occupancy rates and a 15% drop in 'Per Household Consumption' as customers change from being unmeasured to measured. This can be shown;

Table 6.14: Cost per MI/d saved for each of the metering types excluding PMX

Cost per £m/MI/d saved	Amp 7	Amp 8	Amp 9	Amp 10	Amp 11
Selective	£5.23m/(MI/d)	£5.05m/(MI/d)	£5.28m/(MI/d)	£6.90m/(MI/d)	£8.61m/(MI/d)
Meter Option	£4.54m/(MI/d)	£4.39m/(MI/d)	£4.59m/(MI/d)	£5.99m/(MI/d)	£7.48m/(MI/d)
New Supply	£5.86m/(MI/d)	£5.66m/(MI/d)	£5.92m/(MI/d)	£7.73m/(MI/d)	£9.65m/(MI/d)
Enhanced (including change of occupancy)	£4.29m/(MI/d)	£4.14m/(MI/d)	£4.33m/(MI/d)	£5.66m/(MI/d)	£7.06m/(MI/d)

Compulsory scenario (AMP 7)

Costs have also been determined for a 'Compulsory Metering Option' for AMP7. Note this is based on available data and the cost savings are not directly comparable with those above due to differing assumptions about the speed and location of a potential metering. As above, they also exclude PMX.

Table 6.15: 'Compulsory Metering Option' for meter installation excluding PMX

Programme	No. Installs AMP 7	AMP 7 Cost	AMP 7 Cost per Meter	AMP 7 Saving MI/d	AMP 7 Cost per MI/d
Enhanced	52,293	£12,779,619	£244.38	3.17 MI/d	£4.03m per MI/d
Meter Option	32,319	£9,092,208	£281.33	1.96 MI/d	£4.64m per MI/d
Selective	1,156	£484,333	£418.97	0.07 MI/d	£6.92m per MI/d
Total / Average	85,768	£22,356,160	£260.66	5.20 MI/d	£4.30m per MI/d

In practice, compulsory metering will be more expensive compared to BAU. To illustrate this, the table below presents the relative changes for each programme in terms of installations, cost and average meter installation cost.

Table 6.16: Compulsory Metering Option % changes from BAU

Programme	No. Installs AMP 7	Cost	Cost per Meter
Enhanced	156%	164%	105%
Meter Option	95%	97%	103%
Selective	95%	120%	127%
Total	125%	127%	102%

Other changes

Timing of improvements to drought resilience

We are planning for all our customers to be protected against the risk of severe restrictions relating to a severe drought by the end of AMP7 (end of March 2025). In our WRMP we included the impact on deployable output in planning year (financial year) 2024-25. This has the effect of driving related scheme delivery earlier than the end of AMP7. Therefore, in our WRMP we propose to move the drought impact to 2025-26; with scheme delivery at the end of AMP7, we will show the benefit from these schemes in 2025-26. There will be no change to security of supply. We will update the Water Resources Planning Tables to reflect this and clarify any related statements in the WRMP and supporting technical reports.

6.4.11 Leakage reduction - Options considered

We are determined to continue to improve on our excellent recent performance reducing leakage. To this end we considered a large number of sub-options for leakage reductions activities which covered approximately 1,700 specific interventions. We ordered this long list of detailed sub-options by Average Incremental Cost (AIC) and adjusted for overlaps and dependencies. We used this AIC ranking to generate three sub-option bundles for each of our WRZs. The three bundles align to our broad option packages which cut across leakage, metering and water efficiency. These options are above and beyond the activities we are currently undertaking..

The three leakage options bundles we considered are:

- 1. Extended** - with expected water savings of 10MI/d or up to 15MI/d if associated with smart metering (AMP7) - 38MI/d by the end of the WRMP period (including smart meter savings).
- 2. Extended plus** - an ambitious bundle aiming to achieve water savings of 23MI/d or up to 30MI/d in association with smart metering (AMP7) - nominal 70MI/d by the end of the WRMP period (including smart meter savings).
- 3. Aspirational** - a challenging package with high water savings and high costs, aiming to achieve water savings of 38MI/d or up to 45MI/d in association with smart metering (AMP7) - nominal 105MI/d by the end of the WRMP period (including smart meter savings).

Within these three bundles we have considered six direct leakage reduction options and six options for activities that enable further leakage reduction.

Leakage reduction sub-options

The sub-options we have considered to enable reduced leakage are outlined in the table below.

For all of these sub-options, except the targeted investigations, the potential sites where this sub-option could be deployed have been allocated to the strategic options on the basis of the AIC ranking:

- The least costly sites being included in the 'Extended' package,
- The next tranche of sites in the 'Extended Plus' package and,
- The most expensive sites in the 'Aspirational' package.

A detailed list of the assumptions for the leakage and leakage enabling options is provided in our consultants report.

Figure 6.10: Leakage savings for each option, over the WRMP plan period (this also shows the leakage savings associated with the smart meter roll-out) for each modelled option

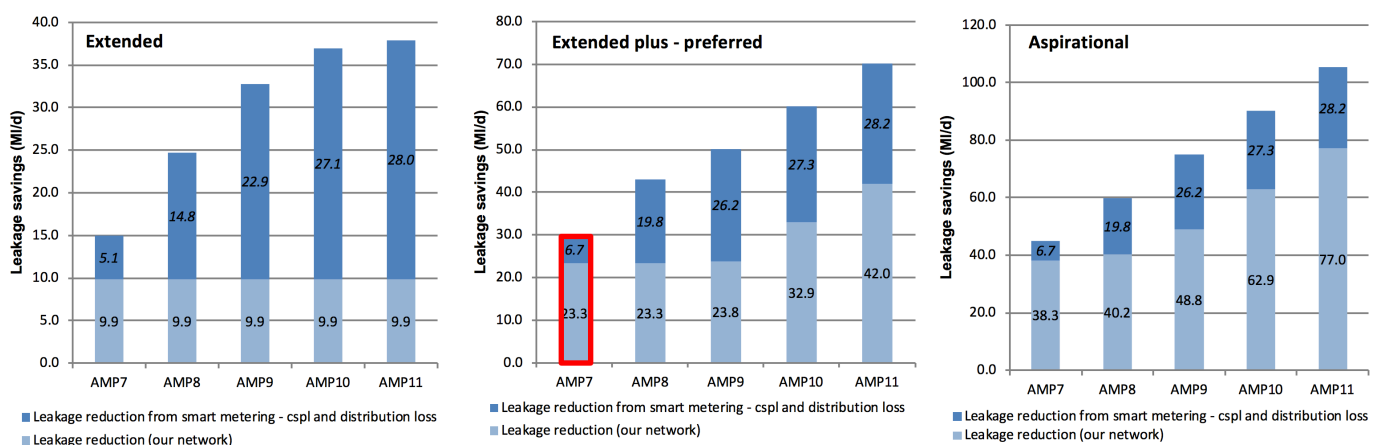

As noted the Ofwat Draft Methodology requires a 15% reduction in leakage in AMP7, as achieved in the preferred 'Extended Plus' option (15% of 177 MI/d = 26 MI/d).

6.4.12 Leakage reduction sub-options

Table 6.17: Leakage sub-options

Type	Name	Description
Leakage enabling	Identifying previously unknown consumption	Use of analytical methods and surveys to identify customers that are likely to be using more water than estimated by comparing metered consumption to expected consumption for customers with the same given characteristics. These properties are then examined in the field to identify unknown connections or previously under-registering meters. This includes improving understanding of plumbing losses, especially within properties. Plumbing losses are part of consumption, but because they appear in night flows they can be mistaken for leakage.
	Improved district metered area meter operability	Increased maintenance expenditure on district metered area (DMA) meters to improve reliability and data collection. This will provide leakage data more reliably which will allow high leakage DMAs to be identified and allow rises in leakage to be identified quickly. In line with regulatory requirement to ensure 95% of DMAs are operational.
	More large user logging and bulk metering to improve understanding	Increase the number of large non-household consumer meters and Water Recycling assets that are permanently or temporarily logged, particularly for night flows. Provides better information on where leakage exists for operational use and also provides greater accuracy in leakage reporting.
	Trunk main and service reservoir leakage reduction by improved metering	Increased metering of our upstream network. Improving understanding where water flows and where losses are occurring. Enabling better regulatory reporting and better targeting of leakage reduction methods in the right places.
	Raw water mains monitoring	Increased metering of our upstream raw water network. Improving understanding where water flows and where losses are occurring. Enabling better regulatory reporting and better targeting of leakage reduction methods in the right places.
	Metering SR inlets and outlets	Increased metering of our reservoir inlet and outlet meters. Allowing reservoir losses to be separated from other distribution losses, improving understanding where water flows and where losses are occurring. Enabling better regulatory reporting and better targeting of leakage reduction methods in the right places.
Leakage reducing	Targeted investigation of high leakage DMAs	Investigation of DMAs with high leakage or with high recurrence rate and resolution of the cause of the problem. This will include a seven-stage programme starting with data gathering and ending when resolved. Resolution may range from correction of erroneous data to significant infrastructure renewal or redesign.
	Targeted extension of pressure management	Design, construction, and commissioning of new pressure management schemes. Schemes are of two types - those at a specific level (e.g. a DMA) and non-specific schemes at a planning zone level.
	Upgrade of controllers for PRVs and pumps	Retrofit improved controllers to pumps and valves to enable more precise and responsive pressure profiles to be maintained that minimise leakage while providing adequate pressures at critical points at all times.
	Jackhead tower optimisation	Redesign of Jackhead tower systems to reduce the range of pressures in the area supplied. Variable pressure and high pressures causes higher burst frequencies and higher leakage levels than would occur if fed at a lower and more even pressure.
	Transient investigations	Investigating the existence of pressure transience using transient loggers, tracing the sources of those transients and removing the causes. This is a newly developed branch of leakage control activity.

The leakage sub-options represent a range from tried and tested to innovative and less certain. The table below captures the basis for our assumptions.

Table 6.18: Leakage source of assumptions

Name	Notes
Targeted investigation	Resolution of leaks can occur at different stages of investigation, resulting in a wide range of actual costs of resolution. We have used the results of investigations and examples of costs and the proportion of investigations solved at the different stages to project costs and savings. The expected savings from customer supply pipe leaks has been factored down to account for smart metering option.
Pressure management	These schemes may cover the same DMAs that are identified in the high leakage DMA investigations - the scheme savings are factored down to take account of these overlaps. An allowance was also made to account for the number of schemes that would prove unfeasible at the point of detailed design or implementation. Cost and benefit information is based on our experience of the cost of these schemes to date in AMP6. Savings projected beyond specific schemes already identified using the UKWIR 2011 Long Term Leakage projection method.
Pumps and valves	These options are for specific existing schemes using the costs and benefits calculated from leakage levels, pressures and burst rates for the areas affected. Extrapolation of these options to cover schemes not yet identified is implicitly included in the extrapolation of the "Extension of Pressure Management" option using the UKWIR 2011 Long term Leakage methodology. Cost and benefit information based on our experience of the cost of these schemes to date in AMP6.
Tower optimisation	The costs and benefits estimated are based on a limited data set. We have concluded one optimisation scheme and extrapolated to the estimated 35 feasible schemes, which are spread equally across the network.
Transient investigations	Transient investigations are a newly developed branch of leakage control activity. We have used data from our trials to derive cost and benefit estimates that could be made from 50 individual investigations.
High cost intensive investigation	High cost intensive investigation included in the "Aspirational" is based on a very limited data set.

Note that leakage reduction options are assumed to require repeat costs every ten years mainly driven by potential reconfiguration of the network.

6.4.13 Leakage and Small Area Networks (SANs)

For leakage, we have occasionally used an option known as Small Area Networks (SANs). This involves breaking District Metering Areas into smaller units, renewing mains and communication pipes within that area and installing additional monitoring equipment. This approach effectively involves rebuilding our network in specific problem areas.

We have screened out SANs as a stand alone option as it is excessively expensive, although we may renew mains as part of our targeted leakage investigations if warranted. Undertaking a SANs option across our

network would result in a cost per MI/d of water saved several orders of magnitude higher than the next most expensive option.

6.4.14 Water efficiency measures - Options considered

We identified a number of sub-options for water efficiency. These have been identified by drawing on our own research, such as our fact finding visit to Valencia, and the analysis undertaken by the University of East Anglia on our behalf.

The sub-options have been grouped into three packages, aligned to our Extended, Extended Plus and Aspirational strategic options. Each of these sets comprises three exclusive options i.e. low, middle and high savings.

The costs and benefits associated with these sub-options have been assessed exclusive of (or in addition to) the costs and benefits associated with our current baseline strategy.

Our baseline strategy is incorporated within the baseline demand forecast and as such does not form a specific option. Our baseline strategy includes:

- The Potting Shed initiative
- Communications campaigns on discretionary use including events, education, and use of Broadcast Beacons, and,
- Annual awards ceremony.

Table 6.19: Leakage source of assumptions

Customer	'Extended'	'Extended plus'	'Aspirational'
Household	<p>In addition to the baseline activity:</p> <ul style="list-style-type: none"> • Leaky Loos campaign • A rewards scheme for customers who sign-up on the portal • A base Bits and Bobs campaign (up to 15,000 audits) • Free installation of water butts (when purchased by a customer) 	<p>In addition to the Extended option:</p> <ul style="list-style-type: none"> • Multi-utility consumption portal • Provide and install water butts to certain customers • Rebate to replace old toilets • Retrofit 'smart devices' (such as taps) that • Can send data to the customer portal 	<p>In addition to the Extended Plus option:</p> <ul style="list-style-type: none"> • Provide and install water butts to all customers • Use satellite technology to advise customers when to water their gardens
Developers	<ul style="list-style-type: none"> • Redesign of our developer portal to show how to meet per capita consumption (PCC) standards of 110 and 80 l/head/d • Development of a standard blueprint for sustainable gardens 	<ul style="list-style-type: none"> • As in 'Extended' 	<ul style="list-style-type: none"> • Incentivise developers to achieve the 80PCC standard

The three options were modelled in accordance with base assumptions including; the size and demographic of the target customer audience, assumed savings per unit affected, PCC values etc. Due to the interdependencies of the water efficiency options with smart metering, options have been developed for both the 2AMP and 3AMP roll-out. See Section 7.

Figure 6.11: relative savings (MI/d) for each of the water efficiency sub-options, for the WRMP plan period

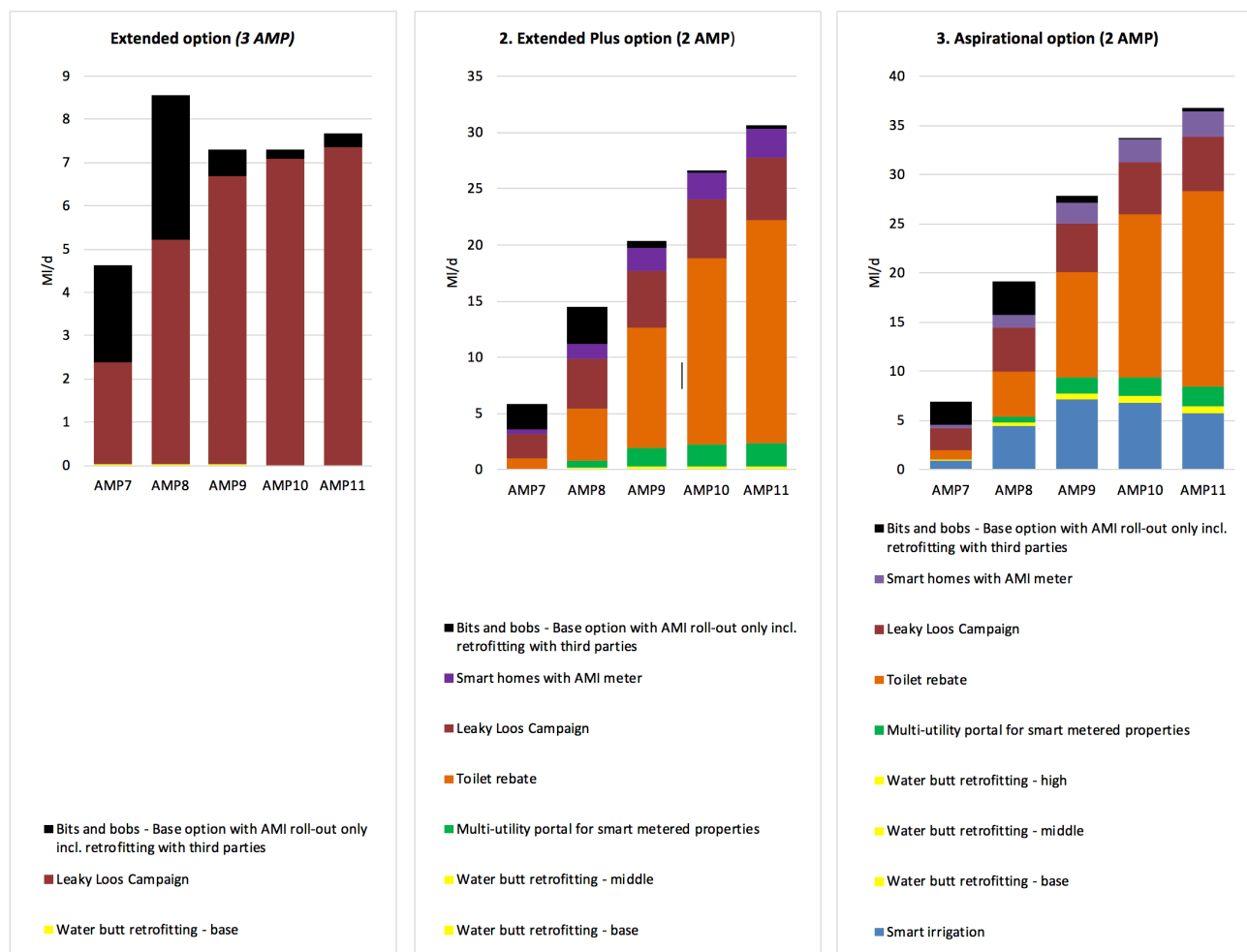

It is noted that the 'toilet rebate' (where we will incentivise customers to replace old leaking toilets) and 'leaky loo' campaign will achieve significant savings within all these options.

This can be attributed to the fact that toilet cistern leaks are typically continuous and have been found to be in the order of 20 litres/hour (478 litres per day).

Consequently, even though we are expecting to rectify a relatively small number of properties, the savings are disproportionately large.

Table 6.20: Key assumptions with regard to toilet leakage reductions

Toilet rebate	Assumed take up of 60,000 over 4 AMP, based upon targeting high leakage level 'Bits and Bobs' visits (i.e. properties with leakage equivalent to 478 l/prop/day) Decay 15 years
Leaky Loos Campaign	Proportions of 'Bits and Bobs' Property visits, reduced to reflect large leakage saving (i.e. properties with leakage equivalent to 478 l/prop/day) - 0.1% measured/unmeasured/new build - Approx 10,000 take up, pre-AMI Replaced with AMI cspl saving post dumb.

6.5 Tariff and price signals

The majority of household customers pay their water bill based on a simple two part tariff structure, with a fixed charge (calculated on a per diem basis) and a uniform unit charge for volumetric usage.

In order to assess the feasibility of more complex tariff options, through the Anglian Centre for Water Studies, we commissioned the University of East Anglia Centre for Competition Policy to review international experience of price and non-price approaches to manage water demand. This research suggested that, before tariffs with differentiated price signals can be implemented successfully, certain preconditions must be met³³ These include, but are not limited to, the points listed below.

- Customers need to understand their consumption and engage positively in managing their demand, otherwise introducing tariff changes (such as Increasing Block tariffs) may have unintended adverse consequences both to customer bills and to demand; and
- Access to near real-time information will be key to inform the customer of the relationship between usage and price, and thus, the impact on bills of customer behaviour.

An analysis of various complex tariff options is set out in Appendix 1. The preconditions for successful implementation of tariffs have not yet been realised. We understand from our engagement with customers that some find their bills and the basis for charging unclear or confusing³⁴ Smart metering could help improve this understanding by making consumption information more visible to customers.

We believe it is necessary that we trial the effects of different tariffs (including the messaging and presentation of tariffs) in our region before we can consider wide-scale roll-out, without effective consequences, such as encouraging consumption for some customers or negatively impacting the vulnerable.

We believe price incentives may well have a place in our future demand management activity and we are continuing our consideration of how these could be tested in the future. We have not included tariffs as a feasible option in draft WRMP 2019.

6.6 Compulsory dumb metering

As we are in an area of serious water stress, we have an obligation to consider the costs and benefits of compulsory dumb metering.

The results from multiple sources show that, generally, customers are much more supportive of compulsory metering than has been the case previously. However, customers who pay measured charges tend to support compulsory metering, whereas those who pay unmeasured charges do not. We believe the higher levels of support for compulsory metering reflect the larger proportion of customers paying measured charges.

Defra's Guiding Principles state that the government does not believe a blanket approach to water metering is the right way forward.

Many of our customers are metered and pay measured charges, and we have found that the remainder are likely to use more water than average. As such, the resulting reduction in consumption from compulsory metering, is unlikely to be of the same order of magnitude as the results achieved to date through our enhanced (opt-in) metering programme. There is limited evidence on the benefits of achieving 100% metering penetration, compared with a counterfactual of high meter penetration.

Additionally, the costs of achieving 100% metering penetration are likely to be high.

We believe that compulsory metering could cause affordability problems for some customers and more generally result in a loss of customers' goodwill.

As a result, we have not included compulsory metering in our Draft WRMP 2019. Our strategic demand management options; however, assume that we will reach the limits of feasible meter penetration by the end of AMP8 or 9 (depending on the option). We will be required to reassess the case for compulsory metering in the development of WRMP 24.

6.7 Price Incentives

Whilst we have considered the widest range of demand management options, we have also considered more complex tariffs, for some of our unconstrained options.

A simple, two-part tariff with a volumetric charge per unit of water already sends a price signal to customers about each incremental unit consumed.

However, the tariffs set out below produce more complex price signals relating to overall usage, when that usage occurs and for what purpose. These tariffs send differential price signals to our customers through their bills, that might cause desired changes to their consumption behaviours.

³³ <https://www.acwaterstudies.org/projects/encourage-water-conservation/>

³⁴ Sophie Ahmad, Aug 2017, Customer Research and Engagement Synthesis report, Page 77

This raises the question regarding whether and by how much price signals can affect behaviour, and whether other messaging is required alongside or in place of price signalling in order to properly engage customers.

To help us better understand these options we commissioned the University of East Anglia's (UEA) Centre of Competition Policy to review international experience of price and non-price approaches to manage water demand, with a focus on drawing insights regarding the effectiveness of Increasing Block Tariffs and information-based behavioural interventions.

In summary, the study concluded that:

- Price and information-based interventions can work together to reduce demand, and,
- Price signals work best with engaged customers and alongside relevant and timely information, particularly consumption information.

6.8 Demand and the price of water

A key potential element of residential water demand management is water pricing. By the law of demand, increasing water prices should reduce residential water demand. Academic consensus is that water does not have price-sensitive demand since it has few substitutes. The degree to which price affects demand for a product or service is known as price elasticity. If demand is price inelastic, then changes in the marginal volumetric rate faced by a consumer will have little effect on demand. Demand behaviours are specific to a given set of circumstances or parameters, and may well vary both between customers and between different time periods for individual customers. For example, demands for essential uses of water are less likely to be responsive to marginal price than 'discretionary' uses, such as garden/plant watering. As an example, summer use might be more price elastic than winter use.

Available research and literature on the price elasticity of demand for water has consistently suggested that household demand in our region is likely to be price inelastic.

On occasions we have made specific assumptions for planning purposes; -0.15 being a typical value used in calculations. That is to say, for every 10% change in price, the company has assumed a change in demand in the opposite direction of 1.5%. However, inferring estimates of the price elasticity of demand for water from observed customer behaviour is quite challenging.

Our assumptions on price elasticity for water in our region are consistent with the up-to-date review of overseas evidence carried out by UEA.

The key conclusions of the UEA research in this area are summarised below:

- Household demand is fairly unresponsive to changes in price - 'Water demand is in general price inelastic';
- Summer demand is thought to be more price elastic than winter demand, and similarly outdoor household use is regarded as more price elastic than indoor use;
- There is evidence which suggests that having price information next to consumption information on the bill may increase the price elasticity of demand by a factor of 30% i.e. make demand more responsive to price; and
- The demands of lower income households tend to be more price elastic than those of higher income households.

As the only supplier of water to customers in our region, we have a special responsibility to ensure our charges are fair and customers understand how their bills are calculated. We are also committed to ensuring the affordability of water for customers in our region. There are also questions about how price interventions would sit within a regulatory model based on total allowed revenues. As such, blanket price increases are not acceptable to us, our customers or our regulators.

However, there are more nuanced approaches to sending price signals.

The approaches that we have considered and discuss in more detail in this section are:

- Increasing block tariffs;
- Seasonal tariffs;
- Time-of-day tariffs; and
- Premium tariffs for outdoor use.

6.9 Water tariffs

6.9.1 Increasing block tariffs

Overview

In a block tariff, different unit prices are charged for two or more pre-specified blocks (quantities) of water. An increasing block tariff (IBT) is where the unit price increases with each successive block of consumption. This is different from our current two part tariff of a fixed standing charge and a fixed charge per unit of consumption.

A clear advantage of an IBT is that it attempts to find some balance between the two objectives of affordability and water conservation by providing a cheaper initial block. However, there will still be some trade-off between these two objectives.

We could use IBTs to set lower prices to support essential consumption for all households and higher prices for consumption considered non-essential. For example, if we regard water consumption block w_1 in (figure 6.12) as essential, a low price block p_1 is chosen to make sure w_1 is affordable to all, whereas any consumption beyond w_1 corresponds to the higher block price p_2 to encourage conservation.

There can be multiple blocks above w_1 in order to gradate price signals and prevent cliff-edges. IBTs may therefore be an instrument for achieving a desirable balance among social, economic and political goals.

Figure 6.12: A two block IBT

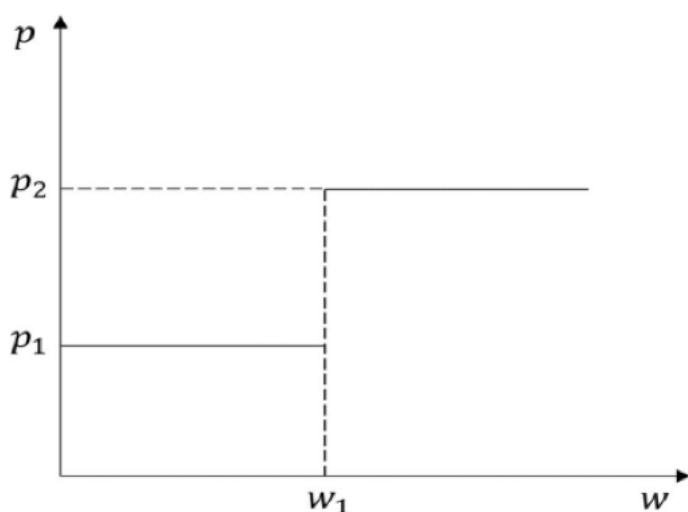

IBTs are in use in several locations around the world, including the USA, Spain, Portugal and Australia.

The effectiveness of IBT systems in practice appears to depend on whether they are appropriately designed, as well as positively received by customers. Challenges may arise at both stages of this process, due to the complexity of an IBT.

Consideration

We have considered the option of developing an IBT system for household customers paying measured charges.

One potential attraction of an IBT system is that its very existence could convey helpful signals to our customers regarding the importance of water conservation, quite apart from the direct effect upon individual consumers' demand from the change in marginal price. The introduction of an IBT might incentivise lower demand, making a significant contribution to our demand management programme.

The replacement of our single volumetric charge with an IBT including multiple marginal volumetric rates could, in principle, bring about a further net reduction in demand in line with the differential elasticity, depending upon types of water usage (i.e. by discouraging customers discretionary use).

All else being equal, higher usage households would see an increase in their bills, whilst lower usage consumers would see a reduction. This could be seen to bring about an improvement in fairness, depending on the size and calculation of the "essential use" block.

Part of the research by the UEA identified factors likely to improve the effectiveness of IBTs. These are identified below.

- Adoption as a response to severe weather conditions, such as a drought.
- Sufficiently high unit prices for high blocks.
- Continuous adjustments of rates and structures when needed.
- Clear price information included on households' bills.
- Adoption for a sufficiently long period.
- Adoption alongside non-price conservation tools.

These factors provide important prerequisites, and some challenges, which would have to be carefully considered before a case could be made for the

introduction of IBTs in our region. In addition, several concerns with IBTs have been identified, as outlined below.

Evidence suggests that it is not possible at this stage to be confident that the introduction of an IBT, at least in isolation from other behavioural initiatives, would have a significant effect on total household demand in our region.

Given the need to maintain the same level of overall revenue recovery in line with regulatory controls, the introduction of a higher consumption block or blocks at a higher marginal price would have to be combined with a lower marginal price for the lower consumption block(s).

This could have unintended negative consequences, such as actually causing an increasing overall demand.

For customers to engage with an IBT structure rationally they must be aware of the need to acquire price and consumption information, and the net benefit of this acquisition must be positive.

If expenditure on the customer's water bill is small relative to their income, for the majority of households, and IBTs are complex, then acquiring the level of information to engage rationally with the price signals may just not be worth it.

If customers do engage, an overall reduction in demand will depend upon the price elasticity of demand for customers using different levels of consumption. It may be that the price elasticity of demand at higher levels of usage is indeed higher than it is for lower levels of usage, in which case a net reduction in demand could be expected.

However, this would have to be established empirically.

All the relevant evidence suggests that it is unlikely to produce large net consumption effects overall. The Gardner study³⁵ found household customers in the South East Water area did not show any demand reduction at all during the IBT trial, compared with the control group. Even in parts of the world that are characterised by higher levels of non-essential use, IBTs are often found to have little or no effect.

It would not be sensible or fair to introduce a simple IBT structure with a uniform fixed size for the first block, because this would mean that low occupancy households with relatively high levels of demand (high PCCs) could avoid paying the "premium rate", and high occupancy households with relatively

low levels of demand (Low PCCs) might be unable to avoid it. It seems essential, to relate the size of blocks to household occupancy at least, and potentially other household characteristics, for it to be seen as fair. Acquisition and maintenance of such information would incur significant transaction costs.

If blocks were set on an annual basis, then given the April to March charging year, customers would typically be using up their "basic" blocks during summer months, and only going into higher rate block(s) later on in the year, generally during winter.

This suggests it would be beneficial selection of shorter usage periods. Doing so will potentially add complexity and cost to the process, which would require significant engagement and understanding from customers, risking that customers may perceive the tariff as somewhat arbitrary and unfair.

Our evaluation suggests that there are other effects that could raise concerns which would have to be carefully managed e.g. presentation of a higher volumetric rate would require careful positioning with customers and stakeholders, to emphasize that the move would be overall revenue neutral.

The widespread use of direct debit (which brings its own benefits to both customers and the company) would tend to operate in such a way as to weaken the price signals that the tariff structure is intended to convey by inserting several "steps" between individual consumption decisions taken by customers and the billing impact, which they may not then notice.

IBTs are likely to have different effects on different income groups. There is not yet sufficient evidence to be able to understand these effects with confidence. It is possible that, for a given occupancy, higher income groups tend to use more water because they have bigger gardens and luxury appliances such as power showers etc. The counter-argument is that lower income groups may have older (and therefore less water-efficient) appliances (especially washing machines), and are more likely to occupy segments of the housing stock that are characterised by bigger cisterns and perhaps the presence of baths rather than showers. In principle it is possible to reflect such factors in the decision on block sizes, but at a significant cost both in terms of practicality and the sheer volume of information that would need to be gathered.

³⁵ A study based on customers in the Veolia South East company area, and reported in "Residential water demand modelling and behavioural economics", K. Gardner, 2010

6.9.2 Seasonal tariffs

Overview

A seasonal tariff would involve measured households facing a lower volumetric rate during the winter (October to March) and a higher one during the summer (April to September). There are many permutations of seasonal tariffs. “Summer” could last for just two or three months, or as long as seven or eight. In some examples elsewhere in the world there are “shoulder” seasons as well as “peak” and “off-peak” seasons.

The intention of seasonal tariffs is to target and reduce the higher discretionary use of water that occurs in the summer. Summer peak demand is considered to be more price elastic so the increase in tariff could be expected to lead to a reduction in demand, whereas any increase in winter demand, which is considered to be relatively price inelastic, could be expected to be negligible. This would lead to an overall reduction in household demand.

Consideration

Seasonal tariffs for households are in place in several countries around the world, and have been trialled in England and Wales. One notable benefit of having seasonal tariffs in place is that they help to signal the importance of water resource issues.

Seasonal tariffs are more common in parts of the world where the climate is rather hotter than in England and Wales, and where discretionary outdoor use comprises a much higher share of overall household consumption.

We are not confident that seasonal tariffs would provide a substantial reduction in demand. The results from very limited trials in England and Wales are somewhat mixed. A recent trial by Affinity Water in the Bishops Stortford area did not find that customers on a seasonal tariff behaved differently from a control group. However, an earlier trial by Wessex Water suggested that higher tariffs in summer did yield what the company described as “small additional demand management benefit”.

To give an idea of possible orders of magnitude, it is estimated that household demand is, on average, 5% higher in the six summer months of April to September than in winter.

- Supposing that a seasonal tariff consists of a summer rate that is 30% higher than the winter rate, and that summer demand has a price elasticity of -0.25 (with winter demand being completely price inelastic).

- This would result in an overall reduction in annual consumption of 1.6%. However, the positive result in this instance is dependent on price elasticity being greater in summer than in winter.
- In one UK study, summer use was found to be less price responsive than year round demand, so even the illustrative gains described above may not be achievable.

Other difficulties include:

- Reading meters at the start and end of each tariff period;
- The widespread use of direct debits to pay bills might undermine the price signal, with customers focused on the single direct debit amount without engaging with the intricacies of how it is made up; and
- Seasonal tariffs may be unpopular with customers - the experience of Wessex Water³⁶ suggest customers may see the approach as cynical, especially when it applies to discretionary and essential use.

6.10 Other tariffs

6.10.1 Time-of-use tariff

Time-of-use tariffs are used in other sectors, notably electricity, but are not common in the water sector.

Household consumers generally have diurnal peaks (the early morning and the late afternoon/early evening) and the theory is that by setting prices higher at these times it would encourage customers to shift their demand or to reduce it altogether.

Perhaps there could be a case for time-of-day tariffs in circumstances where there are delivery system constraints such that pressure and continuity are threatened during the height of the daily peaks.

However, water is comparatively easy to store (unlike electricity) and most of the company’s delivery systems include a service reservoir or water tower to smooth those fluctuations.

The very existence of a tariff with differential rates may signal to customers that water is more precious than they had previously thought, and improve attitudes to water usage accordingly. However, the diurnal peaks, by their very nature, reflect a general pattern in household activity specific to those times of day (getting ready in the morning for school/work and coming home to cook, wash etc.).

³⁶ Wessex Water, September 2012, *Towards sustainable water charging*, Page 12

It is, therefore, unreasonable to expect customers en masse to significantly reduce consumption, at these times.

Overall, we do not believe there is any evidence that time-of-day tariffs would have a material or sustained impact on overall water consumption.

6.10.2 Premium tariffs for outdoor use

Neither the seasonal tariff option nor the Incremental block tariff option ensure that the premium tariff rate is targeted only at discretionary outdoor usage. One possibility for overcoming this is to put a separate meter on outside taps and to apply a different, higher, charge to outdoor usage.

One difficulty with this approach is that householders are able to run hosepipes from internal taps out into the garden, so the enforcement of such an arrangement would be problematic.

It would be possible to make it effectively illegal to by-pass the outside tap for outdoor use, and a carefully-designed marketing strategy supported by non-price measures could encourage the majority of customers to think in terms of “doing the responsible thing” when making a decision to use water in the garden. However, appealing to the benefits of a “clear conscience” from a charging perspective could have unhelpful side-effects if it encourages customers to think that they can use as much water as they want because they are doing so legitimately and are paying the higher price for it.

This could be an expensive option as it would require additional metering for external use and may not prove effective, given the price elasticity of outdoor use may be inherently limited.

Conclusions

We believe that more complex price signals may have a role to play in our future demand management activities. However, there are certain preconditions to be met to enable successful pricing interventions.

Our conclusions on these preconditions are outlined below.

- We need to establish the scale of impact that price interventions would have in our region.
- We need to be confident that changing our simple two-part tariffs would have the intended consequences. Therefore, ahead of such an action we would need to undertake robust trials to establish the evidence base.

- The introduction of more complex price signals would need to be part of a wider package of pricing and billing initiatives designed to inform customers and influence their behaviour in such a way as to achieve meaningful reductions in demand.
- We believe that a key prerequisite for extending the use of price signals is that customers have real-time consumption data linked to price information available to them, and that they also understand their usage within the wider context of water conservation.
- To effectively design price interventions, we would need to improve our understanding of customer usage patterns and particularly household occupancy. The roll-out of smart meters will vastly improve the quality of the data we have about consumption. In conjunction with this, engaging with customers via a web-portal, in relation to other ‘non-price’ initiatives, provides a route to obtain information about occupancy.

However, for the next AMP, whilst we expect to be building our capacity to use more complex tariffs, we do not expect to be in a position to meet these preconditions for all our customers.

As we progress the roll-out of our smart metering programme, we will move further in that direction, providing customers with improved understanding of their water consumption.

It is clear that any price interventions need to be supported by other, non-price activities. In the future, there is likely to be a strong link between our activities to promote water efficiency and our ability to successfully implement pricing interventions.

Some of the key non-price interventions that could enable price interventions in the future are described below:

- The provision of technical information on water usage within the home and how it might be reduced.
- The supply of monitoring devices that can be attached to individual appliances, e.g. shower timers.
- Providing comparative information on customers’ usage, such as comparisons with neighbours and/or other households with similar characteristics.
- Encouraging customers to take on challenges or pledges to achieve specified goals over a consumption period.

- Providing feedback on customers' behaviour, including 'alerts' when consumption patterns vary, may indicate possible supply pipe leaks.
- 'Emoticons' to indicate how well a customer is doing in keeping its consumption down.

As our demand management strategy is implemented during AMP7, we will monitor opportunities to trial price interventions. If such opportunities present themselves, we will consider undertaking robust trials that will develop the evidence base for their application.

7. Costs and benefits



Cost benefit summary

Integral to the WRMP process has been the cost-benefit analysis of all the strategic options developed. This section presents the cost-benefit and water saving results by strategic option.

Results can be summarised:

- The Extended Option is cost beneficial, but does not offset predicted growth in demand.

This option does not meet our commitment to reduce leakage by 15% during AMP7.

Additionally, we do not believe that the Extended option is sufficiently ambitious to deliver the water savings that we, our customers and our stakeholders expect.

- The Extended Plus option is cost beneficial overall and has the strongest economic business case of the three strategic options.

This option more than offsets current predicted demand growth.

This option is the only one to remain cost beneficial in the combined stress-testing scenarios.

- The Aspirational option is cost beneficial overall and would deliver the highest level of water savings.

The water savings associated with the Aspirational option rely on more extreme and less well understood activities, and consequently these savings are less certain. This option is less desirable due to the higher costs associated with achieving the water savings.

Overall we conclude that 'Extended Plus' delivers the ambitious water savings we require, but crucially with sufficient levels of confidence in achieving those reductions, whilst being cost beneficial.

7.1 Our approach

Our approach for the assessment of demand management options was structured according to seven steps:

- I. Options definition.
- II. Identification of cost and benefit elements, referred to as building blocks in this report, to be included in the cost-benefit analysis. This step includes itemising the information needed for that calculation; and, where appropriate, includes a set of values and assumptions that could be used in the calculation in the absence of company-specific data.
- III. Assessment of full impact (i.e. costs and benefits) of each option. This step was carried out using bespoke Excel-based models.
- IV. Options comparison and incremental impact calculation.
- V. Creation of strategic option portfolios.
- VI. Generation of sub-option level results for the Economics of Balancing Supply and Demand (EBSB) model.
- VII. Selection of the preferred strategic option representing the preferred demand management strategy.

The approach is illustrated in the following diagram:

Figure 7.1: Option development and appraisal

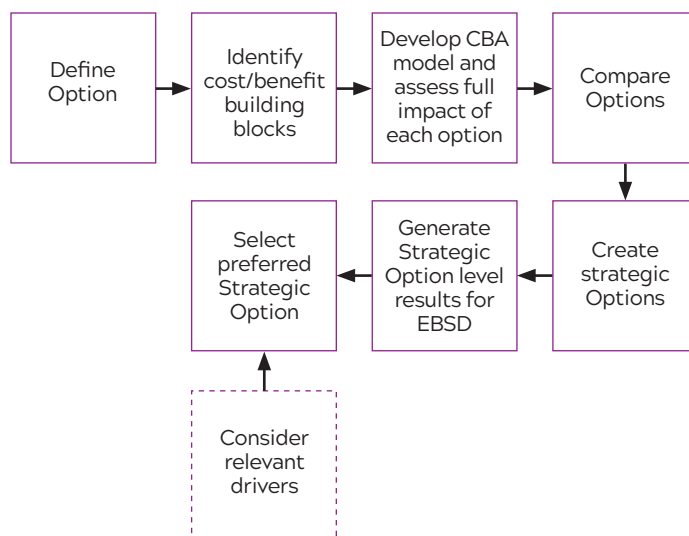

7.2 Sources of evidence and assumptions

The sources of evidence and assumptions that have underpinned the analysis include:

- Anglian Water's own data or data provided by the Company's consultants and contractors;
- Unpublished evidence obtained by Anglian Water through professional contacts and networking with other UK water companies;
- Published sources such as relevant research reports;

Assumptions made in discussions with relevant Anglian Water experts and based on their experience and engineering judgement.

7.3 Cost and benefit building blocks

In order to determine the preferred strategic option, we have undertaken a cost benefit analysis of the three strategic options. This included identification of all of the costs and benefits, the majority of which we have monetised.

Of course there are important non-economic benefits associated with demand management, and it was important to consider the qualitative benefits (that cannot be easily monetised) associated with each strategic option. In addition, all of the strategic demand management options were assessed in the Strategic Environmental Assessment.

7.4 CBA Modelling

To develop our CBA models, we identified a comprehensive list of quantitative costs and benefits, known as building blocks. The development of these building blocks was based on our own data, expertise and experience, as well as published and unpublished information available to us through industry research groups and academic research.

We identified a total of 25 individual building blocks. These building blocks may apply to all, some or only a few of the demand management sub-options. The single, coherent list of building blocks developed across all the demand management options allowed us to develop consistent models to undertake the CBA on a consistent basis. The building blocks we identified are described below.

In order to monetise the cost and benefit building blocks associated with each sub-option, we have developed assumptions about the costs, take-up and water savings. We have used the best information available to us at this point in time. The assumptions are based on our own experiences of costs and

benefits from our extensive demand management activity to date, industry standards and learning from our innovative trials. As our innovative trials progress further data will become available on the most effective demand management interventions. We will continue to refine our plans as we progress our final WRMP and PR19 business plan.

The results of the assessment were extracted from three models developed separately for metering, household water efficiency and leakage. These models allow us to input values for each individual building block associated with each sub-option (e.g. smart metering or retrofitting of devices) over an 80-year period. They enable a cost-benefit comparison of different strategies through the calculation of incremental difference between the impacts of the compared options.

7.5 Benefits

There are a number of quantifiable benefits from demand management. If we can reduce the amount of water consumed by customers and lost through leaks, we will:

- Reduce costs for customers through lower consumption of water
- Reduce treatment and pumping costs for ourselves
- Defer capital investment in supply-side solutions, and
- Reduce CO² emissions from us and customers, as we will be pumping less water around our systems.

The full list of benefits that formed our cost-benefit building blocks considered in our analysis is provided below. Some of the benefits have a broader impact than purely financial - these wider benefits are noted in the following table.

7.6 Value of deferred supply-side capital investment

Reducing demand for water supplies not only reduces operating costs, but has the potential to defer or even avoid capital investment in supply-side schemes. Where there is a forecast deficit in the baseline supply-demand balance, a reduction in demand can reduce, defer or even eliminate that deficit. This can have a significant impact on the selection of supply-side options.

The consideration of deferred supply-side capital investment in setting demand management policy is established industry practice, as demonstrated by the examples set out below.

- The WRC report ‘Leakage Policy and Practice’ states that the benefit of leakage reduction to the water undertaker should be thought of in terms of:
 - i) A reduction in annual operating costs; and,
 - ii) Deferment of capital schemes.
- The Environment Agency, Ofwat and Defra review of the sustainable economic level of leakage (SELL) states that, in determining leakage targets, companies should consider the impact of leakage upon the capital programme and the potential for the deferment of expenditure.
- The UKWIR report ‘Smart metering in the water sector - making the case’ states that companies should consider the impact of smart meters on demand (particularly seasonal peak demand) and the requirement for the development of new water resources.
- In 2011 Ofwat assessed the costs and benefits of faster, more systematic water metering in England and Wales, compared with the then current approach. The assessment includes the impact of reduced demand on both operating costs and capital investment.

In this assessment, we have quantified the impact of each of the strategic demand management options on the supply-side capital investment required to mitigate supply-demand deficits. We have done this by running different scenarios in our EBSD model, and then comparing the scheme selection and associated totex requirements. All of the scenarios were run using a feasible options list made up of supply-side options only.

Scenario 1: Business as usual demand management

- Baseline demand forecast, which assumes that:
- Leakage is held at 177 MI/d
- The number of metered households continues to increase that we reach the limit of feasible meter penetration (95%) by 2034, and,
- Measured household consumption continues to fall as a result of established water efficiency programmes (such as a limited number of ‘Bits and Bobs’ audits, where we retrofit water efficiency devices, and the Potting Shed campaign that provides advice to gardeners).

Scenario 2: ‘Extended’ strategy

- Baseline demand forecast adapted to account for the water savings associated with the ‘Extended’ strategy option
- Total Option savings
 - End of AMP7 - 26MI/d
 - End of AMP11 - 71MI/d

Scenario 3: ‘Extended Plus’ strategy

- Baseline demand forecast adapted to account for the water savings associated with the ‘Extended Plus’ strategy option.
- Total Option savings
 - End of AMP7 - 43MI/d
 - End of AMP11 - 123MI/d

Scenario 4: ‘Aspirational’ strategy

- Baseline demand forecast adapted to account for the water savings associated with the ‘Aspirational’ strategy option.
- Total Option savings;
 - End of AMP7 - 60MI/d
 - End of AMP11 - 164MI/d

For each strategy option, we then calculated the value of the deferred capital investment compared with the ‘business as usual’ scenario.

Consequently, despite the fact that over the WRMP planning period, demand is expected to increase by 109MI/d (DYAA), our demand management strategy has been designed to achieve the full mitigation of this.

This should, therefore, reduce the need for new supply side capacity, although supply side options may still be needed to address sustainability and resilience issues.

We have then apportioned the value of the avoided investment and apportioned it to the relevant sub-options on the basis of water savings attributable to each sub-option.

7.7 Notes on the derivation of deferred supply-side capital investment values

The values for deferred supply-side investment over the 25 year WRMP plan period are considerable; being equivalent to £864m for our preferred option ('Extended Plus'); for the 'Extended' option it is £509m and for the 'Aspirational' option it is £1084m.

These values are noted to play a central role in making the case for these options cost beneficial, and consequently have been scrutinised to ensure that they align with Guidance and are truly reflective of the supply-side costs that would be incurred, if no demand management took place.

These figures have been calculated to reflect TOTEX values in order to ensure that 'like for like' figures are being compared in the CBA.

It has been noted that the current methodology is straightforward and easily understood, however, we will look to improve our understanding of how this figure might be derived to more accurately reflect 'timings' and how investment would be staged through the 25 year period.

External audit has suggested that this figure might be derived to potentially reflect some or all of the following:

- 'Whole life' cost - this could potentially take into account asset lives, but may be much more complex to derive.
- The values could be assessed from the perspective of the 'bill impact' implications of the development of supply-side option. This would be a more 'customer focused' methodology, but might give a more short term focus to the results.
- The benefits could be considered in a more holistic fashion (quantifying natural / environmental / societal capital). This might be much harder to ascertain and quantify, but would tie in with our 'societal valuation' processes.

We will look to investigate these methodologies, as part of our ongoing WRMP review and improvement strategy.

7.8 Demand management options and carbon emissions

As part of the evaluation of the demand management options, potential carbon emission savings and impacts were evaluated. With respect to metering and water efficiency costs and benefits were considered for:

Table 7.1: Cost/benefit analysis with respect to carbon emissions

Carbon reduction from reduced distance travelled for meter reading	<p>Carbon emissions reduction from reduced meter reading travel, due to smart meters and remote access to data.</p> <p>In addition to the reduction in operational costs, the avoided travelling for the purposes of collecting the meter reads reduces carbon emissions; this benefit has been quantified and included within this building block.</p>
Smart Metering - Hot water carbon savings smart meter demand reductions	<p>Reduced carbon emissions from reduced water demand</p> <p>Carbon reduction caused by consumers using less hot water.</p> <p>In line with Ofwat's approach, the calculation of the impact of changes in hot water demand should only consider the carbon emissions associated with it. The actual cost of heating water is already captured by the price of gas and the changes in the overall level of water demand are already accounted for. However, the price of gas does not account for the cost of the associated carbon emissions, which should therefore be accounted for in the cost-benefit analysis. It should be noted that a monetary calculation is not required for households that heat water using electricity, as the cost of carbon emissions associated with electricity generation is already included in electricity prices.</p> <p>Thus:</p> <p>Carbon impacts associated with reduced demand for water are assessed in the following way:</p> <ol style="list-style-type: none"> Carbon emissions associated with the direct use of electricity are not monetised separately, as electricity prices already account for this cost. Hence the carbon emission costs associated with pumping of water are already included in the electricity costs from pumping the water. Carbon emissions associated with other forms of fuel (gas, oil, petrol, diesel, etc.), along with non-electricity embedded carbon, do have a monetary value assigned to them. In line with Ofwat's approach, the calculation of the impacts from changes in hot water use in the home only considers the carbon emissions associated with those changes. The monetary value was therefore calculated for the non-electricity heating of water.
Water Efficiency - Hot water carbon savings - measured	<p>Average annual household electricity consumption is multiplied by assumed percentage of electricity consumption attributable to heating water.</p> <p>This is then multiplied by the percentage household water saving achieved by the given water demand-reduction option, to give the annual household electricity saving.</p> <p>This is then multiplied by the assumed carbon emissions per unit of electricity consumption to give total saved carbon emissions.</p> <p>The same process is followed for gas.</p>
Operational costs of installation	<p>Carbon costs have been calculated to reflect the installation of the metering network system.</p>

For the smart metering programme, we will reach the feasible maximum installation of 95% by the end of AMP8. No additional carbon emissions (above BL) associated with the operation of smart meters was modelled. However, a determination of the additional carbon associated with the initial installation of smart meters was included. Carbon savings have been quantified as follows:

Table 7.2: Carbon savings associated with the 2AMP 'Smart Metering' programme.

Demand management option metering	AMP7	AMP8	AMP9	AMP10	AM11
Hot water carbon tonne CO2e per AMP	73,993	182,695	234,304	245,510	255,444
Meter reading distance travelled carbon tonne CO2e per AMP	230	615	801	839	874
Meter installation carbon tonneCO2e per AMP	- 1,193	- 1,757	-	-	-
Carbon saving tonne CO2e per AMP	73,029	181,552	235,105	246,349	256,318
CUMULATIVE Carbon saving tonne CO2e	73,029	254,582	489,686	736,035	992,353

Note:

+ve number means carbon saved

-ve number means carbon created

For metering, both carbon is both saved and generated

For the water efficiency measures, no additional carbon emissions (above BL) were included in the analysis. The carbon savings can be broken down per water efficiency measure as below:

Table 7.3: Total Carbon savings associated with the individual water efficiency measures (additional to smart metering)

Demand management option - water efficiency and behaviour (WRMP table ref. WEF2 - HH consumption)	AMP7	AMP 8	AMP 9	AMP 10	AMP 11
Bits and bobs - Base option with AMI roll-out only incl. retrofitting with third parties - (Hot water carbon) carbon tonne CO2e per AMP	16,855	24,850	4,647	1,463	2,558
Multi-utility portal for smart metered properties - (Hot water carbon) carbon tonne CO2e per AMP	200	6,335	17,557	20,796	21,896
Smart homes with AMI meter - (Hot water carbon) carbon tonne CO2e per AMP	3,077	10,347	15,340	16,649	17,651
Water Efficiency -(Hot water carbon) carbon tonne CO2e Total per AMP	20,132	41,533	37,544	38,909	42,104
CUMULATIVE Carbon saving tonne CO2e	20132	61,665	99,209	138,118	180,222

Note:

+ve number means carbon saved

For water efficiency, only hot water carbon savings generated

For the leakage reduction programme, operational carbon has been included in baseline leakage reduction with no associated operational carbon emissions; embodied carbon has been quantified as follows:

Table 7.3a: Total Carbon savings associated with individual leakage measures

Demand management option - Leakage reduction (WRMP table ref. LKG1)	AMP7	AMP8*	AMP9	AMP10	AMP11
Intelligent Systems - Advanced Flow Sensing	283	0	8	109	111
Intelligent Systems - Advanced Pressure Sensors	483	0	13	185	190
Intelligent Systems - Automated Network Assets	222	0	6	85	87
Leakage combined infrastructure renewal/optimisation scheme	2570	0	72	986	1010
Leakage small area network	560	0	16	215	220
Leakage targeted mains replacement scheme	1314	0	37	504	517
New Leakage Management - Intelligent Systems Advanced Noise Sensors	514	0	14	197	202
Sum of Embodied Carbon (tonne CO2e) from enhancement per AMP	6,256	0	174	2401	2460
Leakage Ml/d saved	23.35	0	0.65	8.96	9.18

*Note there is no additional enhancement in leakage in AMP 8, as additional leakage reductions (cspl) arise from the full introduction of smart metering.

7.9 Qualitative benefits

As well as quantitative benefits, we considered a wide range of qualitative benefits. These are benefits that are important to us and our stakeholders, but cannot be easily monetised.

These include items such as:

- Water left in the environment as a result of demand management activity
- Helping connect customers to their environment
- Improved resilience of our systems
- Offsetting demand growth, which helps us to manage deterioration risk
- Offsetting or mitigating the impacts of climate change, and,
- Enabling future innovation, such as smart meters potentially unlocking smarter tariffs.

We identify which qualitative benefits have informed our decision making when we discuss our decisions.

7.10 Outputs

The results of the assessment were derived using models developed separately for metering, water efficiency/behaviour and leakage, which allowed us to input values for each individual impact associated with the introduction of a specific measure (e.g. smart metering or retrofitting of devices over an 80-year period) and enabled a cost-benefit comparison of different strategies through the calculation of incremental differences between the impacts of the compared options.

7.11 Benefit categories

Table 7.4: Benefit building blocks

Impact	Description	Leakage	Metering	Water efficiency
Zero Flow Stop detection	Improved detection of 'unoccupied' properties that are actually occupied, leading to generation of revenue.		<input type="checkbox"/>	
Distribution system losses reduction	Reduced distribution losses, as the result of fewer leaks or quicker repairs. As well as the monetised benefit there are significantly wider benefits through lower abstractions and water remaining in the environment.	<input type="checkbox"/>	<input type="checkbox"/>	
Plumbing losses reduction	Reduction of plumbing losses within customer properties. As well as the monetised benefit there are wider benefits through lower abstractions and water remaining in the		<input type="checkbox"/>	<input type="checkbox"/>
Reduced repair costs	Benefit from a reduced number of asset repairs.	<input type="checkbox"/>		
Reduced customer contacts (e.g. from more accurate billing)	Fewer customer enquiries regarding their bills as information accessible through the web portal.		<input type="checkbox"/>	
Reduced distance travelled for meter reading	Carbon associated with emissions due to meter-reading travel. As well as the monetised benefit, there are wider benefits through reduced CO ₂ emissions.		<input type="checkbox"/>	
Reduced level of customer use (average and/or peak)	Reduced average water use by customers. As well as the monetised benefit there are wider benefits through lower abstractions and water remaining in the environment.		<input type="checkbox"/>	<input type="checkbox"/>
Customer supply pipe losses (CSPL) reduction	Benefit of reduced customer supply pipe leakage. As well as the monetised benefit there are wider benefits through lower abstractions and water remaining in the environment.	<input type="checkbox"/>	<input type="checkbox"/>	
Hot water carbon savings	Reduced carbon emissions as customers use less hot water. Calculated in line with Ofwat's approach. As well as the monetised benefit, there are wider benefits through reduced CO ₂ emissions		<input type="checkbox"/>	<input type="checkbox"/>
Customer valuation	Customer preference from societal valuation studies. Evaluated through customer valuation work package and added to overall CBAs as a benefit.	<input type="checkbox"/>	<input type="checkbox"/>	<input type="checkbox"/>
Value of deferred supply- side capital investment	The financial benefit of deferred and avoided costs associated with developing new supply capacity.	<input type="checkbox"/>	<input type="checkbox"/>	<input type="checkbox"/>

7.12 Cost categories

The full list of costs that formed out cost-benefit building blocks considered in our analysis is provided below.

Table 7.5: Benefit building blocks

Impact	Description	Leakage	Metering	Water efficiency
Asset capex cost	Cost of purchasing the equipment and assets required to realise a sub-option.	<input type="checkbox"/>	<input type="checkbox"/>	
Asset replacement cost	Cost of reactive/proactive replacement of the assets (faulty; at the end of asset life).	<input type="checkbox"/>	<input type="checkbox"/>	
Telecommunications capex (IT)	Cost of purchasing and installing communications equipment to operate data transmission systems. The cost of this equipment (for example, data collectors and radio masts) would also be accounted for in this impact if borne by us.		<input type="checkbox"/>	
Telecommunication opex (IT)	The operating costs for communications, such as data costs, on-going licence fees and maintenance.		<input type="checkbox"/>	
Customer engagement cost	Cost of awareness campaigns and customer education, including postage.		<input type="checkbox"/>	<input type="checkbox"/>
Customer portal running cost	Cost of on-going activity to maintain the running of any customer web portals and/or smartphone apps.		<input type="checkbox"/>	<input type="checkbox"/>
Asset installation cost	Cost of installing the assets both during the initial roll-out and when they are replaced as they reach the end of their useful life.		<input type="checkbox"/>	
Operating cost	On-going cost associated with operational activity, e.g. meter reading for metering options.	<input type="checkbox"/>	<input type="checkbox"/>	
Maintenance cost	Cost of maintenance activities, e.g. repairs	<input type="checkbox"/>	<input type="checkbox"/>	
OCIP and other Insurances	To cover liabilities, particularly associated with visiting customer properties and retrofitting devices.			<input type="checkbox"/>
Increased repair costs	Cost of additional repairs carried out by us as a result of more leaks being identified.		<input type="checkbox"/>	
Customer supply pipe losses (CSPL) repair costs	Cost of supply pipe repairs incurred by customers following identification of leaks on supply pipes.		<input type="checkbox"/>	

7.13 Leakage Costs, building blocks and assumptions

The leakage sub-options represent a range of interventions from those that are ‘tried and tested’ to ‘innovative and less certain’. Where possible we have used cost data from our experience of current solutions and from pilot trials of newer techniques. A detailed list of our cost assumptions made in the

leakage business case can be seen in our consultant’s technical report.

The cost building blocks that apply to the leakage reducing options are identified in the table below.

Table 7.6 Leakage cost building blocks

Cost/Benefit Impact	Targeted investigation	Pressure management	Pumps and valves	Tower optimisation	Transient investigations
Asset capex cost	<input type="checkbox"/>	<input type="checkbox"/>	<input type="checkbox"/>	<input type="checkbox"/>	<input type="checkbox"/>
Asset replacement cost	<input type="checkbox"/>	<input type="checkbox"/>	<input type="checkbox"/>	<input type="checkbox"/>	<input type="checkbox"/>
Operating cost		<input type="checkbox"/>	<input type="checkbox"/>	<input type="checkbox"/>	<input type="checkbox"/>
Maintenance cost		<input type="checkbox"/>	<input type="checkbox"/>		
Distribution system losses reduction	<input type="checkbox"/>	<input type="checkbox"/>	<input type="checkbox"/>	<input type="checkbox"/>	<input type="checkbox"/>
Reduced repair cost		<input type="checkbox"/>	<input type="checkbox"/>	<input type="checkbox"/>	<input type="checkbox"/>
Underground supply pipe losses (USPL) reduction	<input type="checkbox"/>	<input type="checkbox"/>	<input type="checkbox"/>	<input type="checkbox"/>	<input type="checkbox"/>

Thus for the leakage options the costs can be summarised (Note these include the cost of intervention only):

Table 7.7: Extended - Note these savings do not include those leakage savings from smart metering for CPSL and plumbing losses

	Cost (AMP 7)	Saving (AMP7)	Cost (AMP 11)	Saving (AMP 11)
Total financial (pre financing)	£37m	9.9 MI/d	£116m	9.9 MI/d
Total financial (with financing)	£39m		£134m	

Table 7.8: Extended Plus - Note these savings do not include those leakage savings from smart metering for CPSL and plumbing losses

	Cost (AMP 7)	Saving (AMP7)	Cost (AMP 11)	Saving (AMP 11)
Total financial (pre financing)	£72m	23.3 MI/d	£282m	42.0 MI/d
Total financial (with financing)	£77m		£344m	

Table 7.9: Aspirational - Note these savings do not include those leakage savings from smart metering for CPSL and plumbing losses

	Cost (AMP 7)	Saving (AMP7)	Cost (AMP 11)	Saving (AMP 11)
Total financial (pre financing)	£114m	38.3 MI/d	£687m	77.0 MI/d
Total financial (with financing)	£122m		£799m	

7.14 Leakage Benefits

Figure 7.2: Leakage savings for each option, over the WRMP plan period (this also shows the leakage savings associated with the smart meter roll-out) for each modelled option

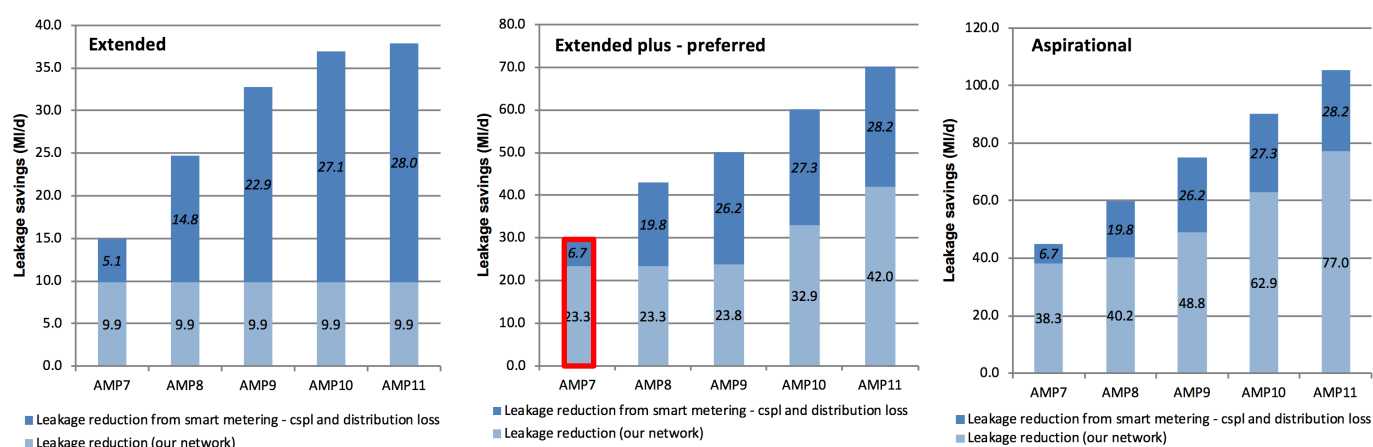

As noted the Ofwat Draft Methodology requires a 15% reduction in leakage in AMP7, as achieved in the preferred 'Extended Plus' option (15% of 177MI/d = 26MI/d).

Reduced distribution losses

The key benefit of the leakage programme is reduced losses of water from our distribution system. By reducing the water we lose through our system we reduce water treatment, pumping and transportation costs. The benefit of the saving is calculated in the model using our assumption on the marginal cost of water, £92/MI.

The case for reducing leakage, however, is broader than the monetary benefit of water saved. Reducing leakage from our networks is important to customers:

- Customers regularly prioritise leakage as an area for additional investment and are particularly concerned about leaks, which are seen primarily as wasteful of a precious natural resource.
- Customers are also concerned that leaks are a disincentive for bill payers to save water, and a sign that the company is not 'doing its bit' to conserve water and invest in the infrastructure.

- A clear driver of concerns about leakage is a perception that they lead to higher water bills.
- Leaks are also seen as a key reason why service interruptions are sometimes necessary.
- Although some customers recognise there will always be some leakage, tackling leakage emerges as a clear priority for further investment.

We have been careful to avoid double counting of reduced distribution losses between the leakage and metering business cases. Both sets of assumptions have been developed in parallel to ensure they are complimentary but do not overlap.

Reduced repair costs

Through proactive activity, we can reduce our reactive operations, avoid bursts and reduce our repair costs.

The benefit of reduced repair costs varies by option and overall our assumptions are modest over the 25 years of the WRMP. We have used data on our experience from AMP6 and on-going trials to determine likely repair cost savings.

Smart metering will support the reduction in leakage on our distribution network through improved leak detection.

The wealth of additional data will give greater confidence in identifying the presence and location of leakage. This better understanding will lead to speedier repairs. How this benefit applies to smart metering is discussed further in the metering section.

Reduced supply pipe losses

Through more intensive leakage investigations, we will identify leaks on our networks and also those on supply pipes. Identifying these leaks will allow them to be repaired, as typically they go unnoticed.

We have developed our understanding of how fluctuating and high pressures affect water mains bursts, discolouration, leakage and the total volume of water used by customers. Water networks that have been 'calmed', to minimise these pressure changes and reduce maximum pressures are proving to be more efficient to run (and more stable for the customer) than uncontrolled pumped or gravity water distribution systems.

The key benefits of pressure management (in order of expenditure saving) are reductions in burst mains, burst services and leakage, requiring less leakage detection and repair effort.

Smart metering and the hourly data this will provide, will support the identification of continuous flows in properties (through monitoring night-flows, when usage should be at a minimum).

Continuous flows are indicative of plumbing losses in the customer's premises or leaking supply pipes. An increase in the identification of these flows will enable more of the associated leaks to be communicated to the customer for repair. This will significantly increase our ability to tackle these losses, as currently these typically go unnoticed. How this benefit applies to smart metering is discussed further in the metering section.

By identifying leaks and reducing bursts, we will reduce the volume of water lost through supply pipes. This will in turn reduce water treatment, pumping and transportation costs. The benefit of the saving is calculated in the model using our assumption on the marginal cost of water, £92/MI.

7.15 Metering costs and benefits

Current actual costs have been used to develop all the options, including costs for below ground meter installation and customer contacts.

Current estimates for the cost of the communications network have been provided by our chosen partners for the Newmarket trial. These costs have been developed to reflect our annual roll-out plan.

Additionally we have used current costs for the smart meters deployed in our ongoing trials.

Labour costs have been considered, from both the perspective of using in-source or outsourced resources.

Current thinking involves a concept of an analogy of a 'Wheel and Hub' with the network being at the centre of system of services, accessible, both to our customers and internally for our monitoring systems. The Network should meet a 'One for all' requirement; for leakage, telemetry, systems monitoring etc.

Key assumptions have informed the metering strategy;

Table 7.10: Key metering assumptions

CBA:	Includes all metering costs (including PMX exchange) discounted over 80 years
Customer use:	15% reduction of PHC when installing new Dumb meter to an unmetered property
	Further 3 % reduction (17.55% in total) when installing new AMI meter to an unmetered property (initial 15% with an additional 3% subsequently applied)
	Alternatively, 3% reduction when replacing existing Dumb meter with AMI meter
CSPL:	Savings based on initial findings from Newmarket. Current estimate 8.2 l/prop/day by AMP11
	Savings based upon 90% of large leaks (paid by customer) and 10% of small leaks repaired (supported by AWS data)
Distribution losses:	5% distribution loss saving after the end of 'AMI upgrade' programme in each WRZ

7.16 Metering quantitative benefits

Reduced customer use

Both dumb metering and smart metering can help reduce household water consumption.

Our assumptions regarding reductions in customer usage have been informed by previous experiences of metering programmes in the UK, early data from our Newmarket trial and the experience to date from the energy smart meter roll-out. The latest research into the effectiveness of metering programmes, especially on the impacts of large-scale meter roll-out for remotely read (but not smart) meters in the UK indicate average savings of up to 16.5%.³⁷ The international evidence for the impact on demand from all types of water metering reports demand savings in a range of 5 to 22%.³⁸ The higher range of savings has been found to be associated with increased engagement with customers and smarter tariffs, such as IBTs.

There is emerging evidence that suggests smart meters can deliver additional water saving benefits, beyond the installation of a dumb meter. Smart metering can reduce household consumption through:

- Improved engagement with the customer (more accurate information accessible via a customer portal; comparisons of water use within peer groups; provision of water efficiency advice, customer engagement programme, etc.),
- The customer being made aware of, and reducing, leaks on their supply pipes and plumbing losses within their property.

We are continuing our analysis of the results from the smart metering trial in Newmarket. The early results are encouraging, as we are seeing demand being reduced by more than 6% when smart meters replace dumb meters. This is based on data collected from January to April 2017 from nearly 5,000 meters.

As more data becomes available from Newmarket and in Norwich, we will continue to improve our understanding of these benefits.

We have also engaged with other UK water companies, such as Thames Water and South Staffordshire Water, to further validate the appropriateness of the assumptions taken forward.

For the purposes of our demand forecast and CBA modelling, we have used the following assumptions:

- A demand reduction of 15% in household consumption on installation of a meter to an unmetered property (based upon the average individual WRZ unmeasured PPC consumption values)
- A further 3% reduction (17.55% in total from the base value) when installing a new smart meter to an unmetered property, and
- Demand reduction of 3% when replacing a dumb meter with a smart meter. This conservative estimate is based on the early results we have from Newmarket and is in line with the experience in the energy sector.

At this point in time, we believe a 3% reduction in consumption, when installing a new smart meter to an unmetered property, is representative of the long term impact we can expect on roll-out.

It is to be noted that the reductions recorded in Newmarket so far, have been recorded in the presence of a very limited roll-out of the consumer portal and we expect to be able to encourage greater savings once our customer engagement package has been fully implemented and refined.

The overall assumptions are in line with Thames Water's findings of a 17% reduction on average in customer use when installing a smart meter at an unmetered property³⁹ This assumption will be kept under review.

In addition to offsetting strategic demand growth, lower consumption results in lower energy (pumping) and treatment costs for water.

This saving is calculated in the model by multiplying the water volumes by using the marginal cost of water - value is £92.22/Ml. Lower consumption will also mean lower bills for customers on a measured charges. As less water is used by customers, there may also be a benefit in reduced costs for wastewater pumping and treatment as less water is returned. However the evidence base for this is not as robust as for reduced water consumption, so we have not quantified this benefit at this time. (It is also to be noted that wastewater returns are heavily weather dependent due to infiltration)

We have not explicitly calculated the impacts of 'time of use tariffs' (or any other smart tariff). We

³⁷ *The Effect of Metering on Water Consumption - Policy Note. University of Southampton. February 2015*

³⁸ *Intelligent Metering Initiative: A Review of Metering Evidence and Gap Analysis Report, UKWIR 08/WR/01/12, 2008.*

³⁹ *Thames Water, July 2017, Demand Management Feasible Options Paper*

have not included these as a specific benefit in the assumptions above. However, we have assumed that over time, 'time of use' or sophisticated tariffs may be introduced to maintain or enhance the water savings. Smart meters are essential to unlocking smarter tariffs.

The ability of smart meters to reduce customer demand is closely interlinked with the provision of information.

There are strong links between proposed smart metering programme and our water efficiency interventions. These will support each other to maximise the reductions in demand that can be achieved. A number of our proposed water efficiency activities are enabled by smart meters, but the benefits of those activities are not explicitly captured in our smart metering CBA.

Reduced distribution losses and more efficient network management

Smart metering will support a reduction in leakage in our distribution network through an improved understanding of water balance data and via easier leak detection (enabling speedier repairs). Smart metering will also provide time series data that can be used to support improved legitimate night use estimates, improving the accuracy of leakage reporting.

We will be able to use our analysis of water balances to provide an improved estimation of legitimate night use (LNU) by using hourly data. We will also be able to correct existing LNU allowances underestimating actual usage, specifically in summer months. This will, consequently, provide clarity on consumption and allow improved targeting of operational efforts to detect leaks on the network.

We have assumed a 5% reduction in distribution losses upon smart meter roll-out completion in a given area.

Smart meters will not only, allow us to understand the volume of water entering our demand management areas (DMAs), however not reaching customers on an aggregate level over a year, but will also allow us to understand seasonal fluctuations, legitimate night usage and transient problems.

Our current assumption is based on our experience so far in the Newmarket trial where four DMAs have around 75% coverage of smart meters. We expect to gain further data on this potential benefit from the Newmarket and Norwich trials. This results in lower energy and treatment costs. The benefit of the saving is calculated in our modelling, using our assumption on the marginal cost of water; £92/MI.

Smart metering combined with DMA monitoring will enable network and customer supply service pipe leakage (cspl) to be identified, pinpointed and targeted more efficiently.

We have also assumed that leakage detection effort will reduce by approximately 10%, resulting in lower active leakage control (ALC) costs. This cost saving has been based upon analysis of our leakage detection operations.

- We analysed data in our 'no leak found' investigations, in order to identify where our teams could not identify an actual leak and occasions where the data we had lead us to incorrectly identify leaks. We believe smart metering data will help us eradicate up to 50% of failed investigations due to there being no leaks. (or by allowing us to be better informed about the location of a leak)

Reduced supply pipe losses

Smart metering will support the identification of continuous flows in properties. Continuous flows are indicative of a leak in the customer's premises or supply pipes. Identification of these flows will enable any associated leaks to be repaired, as these typically go unnoticed. Repair of the leaks results in lower energy and treatment costs, which are calculated using the marginal cost of water of £92/MI.

We have used the data collected from the Newmarket trial to inform our understanding of the levels and order of magnitude of these leaks. The early findings show:

- 7% of unmeasured properties exhibit a continuous flow rate of 23 litres per hour (which equates to 552 l/prop/d), and
- 3% of measured properties exhibit a continuous flow rate of approximately 13 litres per hour (which equates to 312 l/prop/d),
- 5% of measured properties exhibit a continuous flow rate of 3 litres per hour (which equates to 72 l/prop/d),
- 13% of unmeasured properties exhibit a continuous flow rate of 1 litre per hour (which equates to 24 l/prop/d).

We have made the following assumptions regarding repair rates. These assumptions are supported by evidence gathered regarding the proportion of supply pipe leaks located and repaired during our existing metering programme:

- 90% of the leaks in measured properties with flows of 312 l/prop/d are repaired. The high repair rate for this category is achievable because all identified leaks go into the enforcement programme (which currently resolves 99% of customer supply pipe leaks with flow rates greater than 7.5 l/hr).
- 10% of the leaks in measured properties with flows of 72 l/prop/d have been assumed to be repaired. This low repair rate is assumed because currently we do not enforce repairs for low flow rate leaks and the repair is usually reliant on the customers wanting or needing to carry out the repair for other reasons.

At this point in time we have assumed there are no customer supply pipe leakage savings from unmeasured properties attributable to smart metering programme, because there is no financial incentive for the customer to undertake a repair.

However in practice, due to our enhanced programme, some customers will be metered, but paying unmeasured charges and in this case we will be able to identify these leaks.

Reduced customer service costs

Smart metering will reduce the cost of dealing with customer contacts. This is mainly the result of more accurate billing leading to fewer 'bill shocks' for customers (which result in customer contact).

We will also have more detailed and regular information available to our 'Customer Services' staff, which will allow us to answer enquiries more efficiently.

This will be treated separately from the costs of up-front customer engagement regarding the introduction and installation of smart meters.

We have used our existing data on the cost of individual customer contacts to inform our preferred plan. To simulate lower customer service costs, we have assumed that customer contacts would reduce from 0.61 per property per year to 0.39 contacts per property post the smart metering programme.

Recovered revenue from zero flow meters

Smart metering will provide data that can minimise the number of properties classified as voids (i.e. empty properties). This will be facilitated using smart data to identify water use (following period of no use), allowing revenue to be collected from those properties more quickly after occupation.

Our calculations have been based upon national statistics for empty properties (2016 data) where:

- 589,766 empty homes in total; and
- 200,145 i.e. 34% were empty for longer than 6 months.

We have assumed that on average 34% of all voids are empty for 9 months per year and in turn occupied for 3 months per year. The remaining 66% are empty for 3 months per year and in turn occupied for 9 months per year.

Our average revenue per property is £372 per year.

This can potentially be collected if household occupancy and water usage is identified quickly.

We have assumed that 40% of revenue, that is not currently collected, is recoverable.

- This is based on a leakage operations trial we conducted, where void properties were inspected from public footpaths by our leakage investigations teams. This trial gave rise to this 40% figure and is supported by data from our Newmarket trial. (this actually suggests the proportion of void properties that are actually inhabited may be higher than 40%)

Additionally, smart data will help identify un-billed properties. In a district metered area where we were attempting to install meters on 100% of properties identified some properties that were not registered.

More efficient meter reading

A key expected benefit of smart metering will be a reduction in meter reading costs compared with dumb metering. Meter reading using the traditional walk-by or drive-by methods will be phased out and savings will start accruing through AMP7, achieving full impact upon the completion of the smart metering roll-out programme.

The following elements have been included in the quantification of this benefit:

- Reduced household meter reading activity from remote data transfer via Fixed Network.
- Cost saving from stopping leakage reads.

In addition to a reduction in operational costs, the avoided travelling required for meter reads will reduce carbon emissions; this benefit has been quantified and included within this building block.

Replacement of loggers with smart data

We currently install data loggers when a non-household customer exceeds a certain level of daily use or for customers with high levels of night use.

Once the smart meter data network is available, we will look to consolidate systems such that the data these provide would be readily available.

This would potentially negate the need for their replacement.

The total number of existing logging points is 1,500 with the average cost of replacement of £500 per unit. In the CBA it was therefore assumed that the total avoided cost of replacement of these loggers is £750,000 over AMP7.

Reduced carbon emissions

Reduced demand for water has a resultant impact on customer's carbon emissions. We have, consequently, considered carbon impacts associated with reduced demand for water in the following way:

- Carbon emissions associated with the direct use of electricity are not monetised separately, as electricity prices already account for this cost. Hence, the carbon emission costs associated with water pumping are already included in the electricity costs from pumping the water.
- Carbon emissions associated with other forms of fuel (gas, oil, petrol, diesel, etc.), along with non-electricity embedded carbon, do have a monetary value assigned to them. In line with Ofwat's approach, the calculation of the impacts from changes in hot water use in the home only considers the carbon emissions associated with those changes. The monetary value was therefore calculated for the non-electricity heating of water.

7.17 Qualitative benefits

There are a broad range of additional benefits to our smart meter options, beyond those quantified in our CBA and described above. Fundamentally smart meters would allow us to revolutionise the service we provide to our customers.

Customer focus

We believe there is great potential for smart metering to encourage customer engagement, making them part of the 'water saving' journey, and allowing us to produce an individually tailored service.

Moving from estimated bills, or annual meter reading, to more accurate and timely consumption and billing information will assist our customers to understand their water usage (as well as helping to identify leaks).

By providing more online functionality we can provide customers access to a more modern service, which is in line with current digital expectations.

Additionally the data which will be available from smart metering may provide 'peace of mind' for customers, as they can be confident that the meter is recording consumption hour by hour and that any leaks will be identified in a timely manner.

Improving the nature and accessibility of consumption data may also allow opportunities for further demand management through innovative tariffs and other service offerings.

As highlighted in the UEA's research on price and non-price signals, the provision of consumption information is an important enabler for behavioural change.

Providing timely price signals and engaging customers with their own water consumption, is a prerequisite for the potential development of new tariffs.

Understanding local supply and demand issues will allow us to tailor our engagement with customers (for example allowing the potential link behavioural change to conservation efforts on local water courses).

Environmental benefits

By helping to enable demand reductions, smart meters will provide significant environmental benefits. In particular they will mitigate growth, reducing the amount of water abstracted from the environment, potentially offsetting the need for additional supply side investments (which often have larger environmental impacts).

Additionally, in mitigating demand, smart metering and our new methods of engagement, may help improve the resilience of our services to extreme events.

Enabling other activities and our holistic approach

There are strong links between the smart metering options and both leakage and water efficiency options.

As previously discussed our ambitious target for leakage reduction (a greater than 15% reduction, in alignment with Ofwat Guidance) will only be achieved with the supporting data from our smart meter programme.

There is also a very strong link between our smart meter strategy and our water efficiency programme.

A number of our water efficiency options rely on the smart metering option being taken forward.

Our ability to show customers their water use in near real-time, will allow a 'step change' in customer understanding of their consumption, allowing us to tailor water efficiency initiatives directly to our customers.

Smart metering could also allow us to optimise our network operations. Understanding consumption patterns better means we can improve our models and pressure/pumping systems to save energy and costs.

7.18 Metering Scenarios and costs

The smart meter option has been modelled to reflect a 2 AMP, 10 year, roll-out and an option of a 3 AMP, 15 year roll-out.

Figure 7.3: Smart meter savings (2AMP)

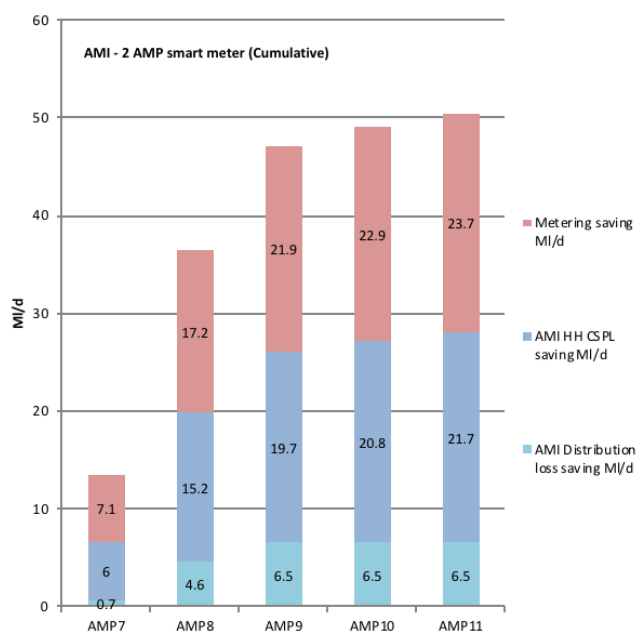

Table 7.11: 2 AMP smart metering costs

2 AMP roll-out	Total Cost (AMP 7)	Avg Saving (AMP 7)	Total Cost (AMP 11)	Avg Saving (AMP 11)
Fixed Capex/Opex inc-Finance	£174m		£734m	
Fixed Capex/Opex pre-Finance	£162m	13.8 MI/d	£595m	51.9 MI/d
Opex saving	£12m		£263m	

Figure 7.4: Smart meter savings (3AMP)

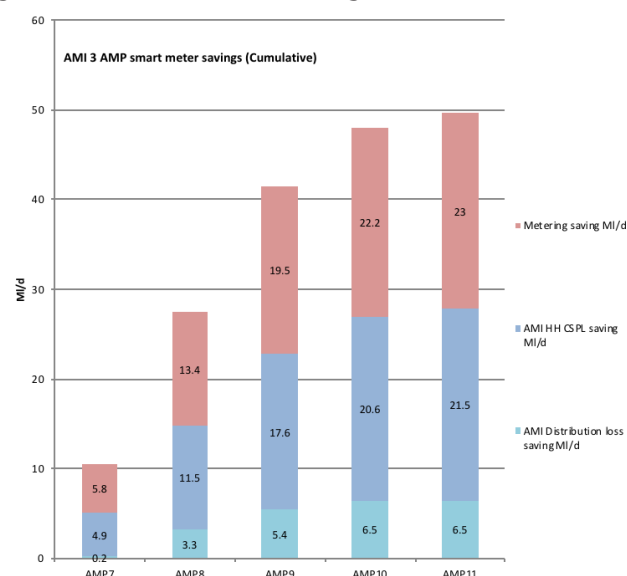

Table 7.12: 3 AMP smart metering costs

3 AMP roll-out	Total Cost (AMP 7)	Avg Saving (AMP 7)	Total Cost (AMP 11)	Avg Saving (AMP 11)
Fixed Capex/Opex inc-Finance	£149m		£707m	
Fixed Capex /Opex excluding-Finance	£139m	10.9 MI/d	£572m	51.0 MI/d
Opex saving	£9m		£241m	

7.19 Water efficiency costs and water savings

Household water efficiency costs and savings Extended Option (3 AMP smart metering roll-out)

Table 7.13: Extended water efficiency savings

Extended option - (3 AMP)		Average water saving per year MI/d	Average water saving per year MI/d
		AMP7	AMP11
1e	Standard blueprint for new home sustainable gardens	-	-
1f	Engagement with new home owners (with any meter type) - AMI roll-out options	-	-
2b	Water butt retrofitting - base	0.023	0.002
3b	Multi-utility portal for smart metered properties	-	-
5b	Leaky Loos Campaign	2.348	7.347
5c	Rewards scheme for sign-up to the portal	-	-
7	Bits and bobs - Base option with AMI roll-out only including retrofitting with third parties	2.250	0.336
		4.6MI/d	7.7MI/d

Costs have been calculated for this option, accounting for the interdependencies of the programmes with the smart meter roll-out programme.

Table 7.14: Differential costs/savings dependent upon 2AMP / 3AMP smart meter roll-out - Extended

Dependency		Cost (AMP7) Exc Opex saving	Avg saving (AMP7)	Cost (AMP11) Exc Opex saving	Avg saving (AMP11)
Combined with Smart metering 2 AMP	OPEX	£9.2m	4.5 MI/d	£32m	5.8 MI/d
Combined with Smart metering 3 AMPs	OPEX	£9.1m	4.6 MI/d	£45m	7.7 MI/d

Figure 7.5: Extended water efficiency savings

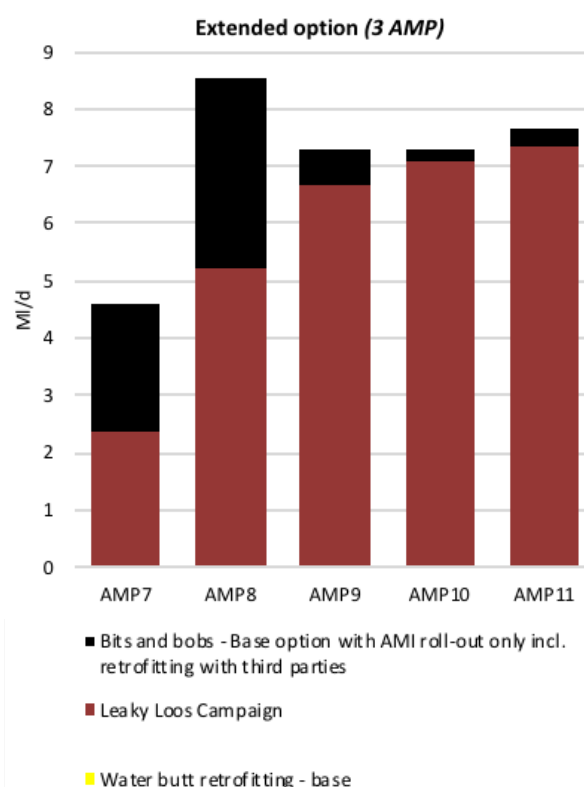

Household water efficiency costs and savings 'Extended Plus' Option with (2 AMP smart metering) (Preferred)

Table 7.15: Extended Plus water efficiency savings

Extended Plus option - 2AMP		Average water saving per year MI/d	Average water saving per year MI/d
		AMP7	AMP11
1e	Standard blueprint for new home sustainable gardens	-	-
1f	Engagement with new home owners (with any meter type) - AMI roll-out options	-	-
2b	Water butt retrofitting - base	0.022	0.001
2c	Water butt retrofitting - middle	0.038	0.344
3b	Multi-utility portal for smart metered properties	0.018	2.005
4	Toilet rebate	0.908	19.892
5b	Leaky Loos Campaign	2.206	5.501
5c	Rewards scheme for sign-up to the portal	-	-
6	Smart homes with AMI meter	0.414	2.546
7	Bits and bobs - Base option with AMI roll-out only including retrofitting with third parties	2.250	0.336
		5.86 MI/d	30.6MI/d

Costs have been calculated for this option, accounting for the interdependencies of the programmes with the smart meter roll-out programme.

Table 7.16: Differential costs/savings dependent upon 2AMP / 3AMP smart meter roll-out - Extended Plus

Dependency		Cost (AMP7) Exc Opex saving	Avg saving (AMP7)	Cost (AMP11) Exc Opex saving	Avg saving (AMP11)
Combined with Smart metering 2 AMP	OPEX	£16m	5.9 MI/d	£93m	30.6 MI/d
Combined with Smart metering 3 AMPs	OPEX	£15m	5.7 MI/d	£88m	31.1 MI/d

Figure 7.6: Extended Plus water efficiency savings

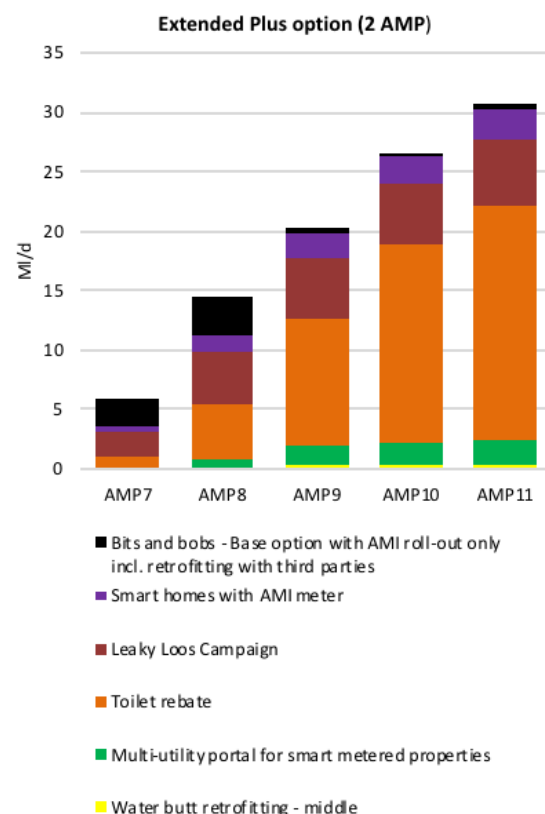

Household water efficiency costs and savings 'Aspirational' Option (2 AMP smart metering)

Table 7.17: Aspirational water efficiency savings

Extended Plus option - 2AMP		Average water saving per year MI/d	Average water saving per year MI/d
		AMP7	AMP11
1e	Standard blueprint for new home sustainable gardens	-	-
1f	Engagement with new home owners (with any meter type) - AMI roll-out options	-	-
2a	Smart irrigation	0.986	5.761
2b	Water butt retrofitting - base	0.022	0.001
2c	Water butt retrofitting - middle	0.038	0.344
2c	Water butt retrofitting - high	0.038	0.344
3b	Multi-utility portal for smart metered properties	0.018	2.05
4	Toilet rebate	0.908	19.892
5b	Leaky Loos Campaign	2.206	5.501
5c	Rewards scheme for sign-up to the portal	0	-
6	Smart homes with AMI meter	0.414	2.546
7	Bits and bobs - Base option with AMI roll-out only including retrofitting with third parties	2.250	0.336
		7.49 MI/d	36.7 MI/d

Costs have been calculated for this option, accounting for the interdependencies of the programmes with the smart meter roll-out programme.

Table 7.18: Differential costs/savings dependent upon 2AMP / 3AMP smart meter roll-out - Aspirational

Dependency		Cost (AMP7) Exc Opex saving	Avg saving (AMP7)	Cost (AMP11) Exc Opex saving	Avg saving (AMP11)
Combined with Smart metering 2 AMP	OPEX	£30.6 m	6.9 MI/d	£172 m	36.7 MI/d
Combined with Smart metering 3 AMPs	OPEX	£29.2 m	6.6 MI/d	£166 m	37.7 MI/d

Figure 7.7: Aspirational water efficiency savings

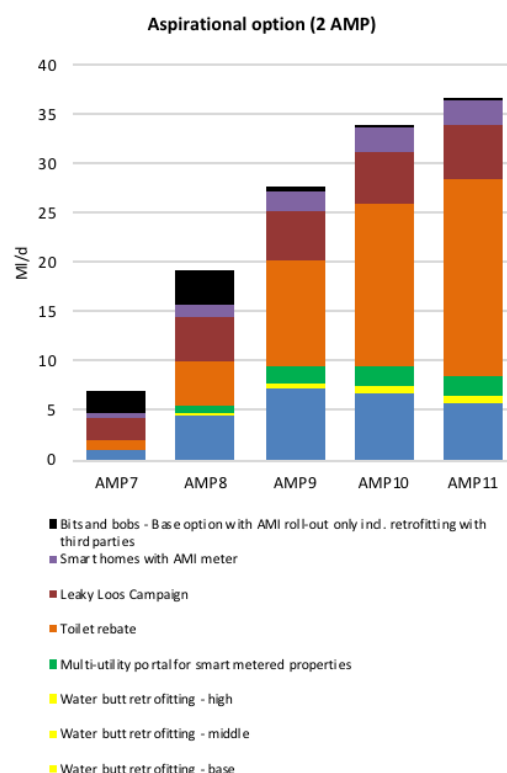

7.20 Water efficiency building blocks, assumptions and benefits

Plumbing loss reduction

Leaks within the customer's premises are known as plumbing losses. These are considered to be consumption rather than leakage but are nevertheless a waste of a precious resource. By promoting awareness of leaky loos and encouraging their replacement, we can reduce these losses of water and customers will save money on their water bills. We have quantified this benefit using the marginal cost of water value which is £92/ML.

Reduced customer use

There is a clear desire from our customers to save water. Our customers believe this should be driven by us offering a service tailored to individual needs and requirements. Customers generally express a willingness to have water efficient products installed in their homes if we provide a fitting service.

Through our water efficiency options and smart metering we have an opportunity to support customers using significantly less water. We have been mindful of this linkage in our analysis and have taken careful steps to avoid double counting. The high proportion of our customers paying measured charges means that if customers use less water, they will save money on their water bills.

In addition to offsetting strategic demand growth, lower consumption results in lower energy (pumping) and treatment costs for water. This saving is

calculated in the model by multiplying the water volumes by using the marginal cost of water value which is £92/ML.

Hot water carbon saving

Reduced demand for water has a knock on impact for customer's bills and carbon emissions. Heating water in the home accounts for up to 15% of household energy bills according to the Energy Saving Trust. We have considered carbon impacts associated with reduced demand for water in the following way:

- Carbon emissions associated with the direct use of electricity are not monetised separately, as electricity prices already account for this cost. Hence the carbon emission costs associated with pumping of water are already included in the electricity costs from pumping the water.
- Carbon emissions associated with other forms of fuel (gas, oil, petrol, diesel, etc.), along with non-electricity embedded carbon, do have a monetary value assigned to them. In line with Ofwat's approach, the calculation of the impacts from changes in hot water use in the home only considers the carbon emissions associated with those changes. The monetary value was, therefore, calculated for the non-electricity heating of water.

Some of the key assumptions have been based upon our internal findings and can be summarised:

Table 7.19: Key assumptions

Ref.	Building Block	New Assumptions
	All	Option impact: Assumed savings vary by option, demographic and uptake.
4	Toilet rebate	Assumed take up of 60,000 over 4 AMP, based upon targeting high leakage level 'Bits and Bobs' visits (i.e. properties with leakage equivalent to 478l/prop/day) Decay 15 years
5b	Leaky Loos Campaign	Proportions of 'Bits and Bobs' Property visits, reduced to reflect large leakage saving (i.e. properties with leakage equivalent to 478l/prop/day) - 0.1% measured/unmeasured/new build - Approx 10,000 take up, pre-AMI Replaced with AMI cspl saving post dumb.
6	Smart homes with AMI meter	Additional PHC saving 4.6% target reduced from 10% AMI to 5% installed AMI base - Total smart home 500,000 by AMP11 (with smart devices)
7	Bits and bobs - option with AMI roll-out only incl. retrofitting with third parties	For AMI roll-out - Bits and Bobs visits set to 15,000 per year. Non-AMI Bits and Bobs set at Low, 15,000 per year Medium - approx. 40,000 per year High - approx. 55,000 per year Saving 50l/prop/year Decay rate set to 5 years in alignment with PR14

Costs

The costs of our water efficiency sub-options are largely operating costs. The main costs are:

- System operating costs, for example, the online water calculator for developers
- Operating costs, such as home audits
- Customer engagement costs, associated with customer facing campaigns and information provisions, and
- Portal running costs, to maintain the operation of the customer facing portal.

The costs and benefits of our Bits and Bobs audits are relatively well understood given the on-going programme during AMP6.

Maintaining changes in customer behaviour has been found to prove difficult. We have, therefore, assumed that water savings will decay to 0% five years after the audit.

For some of the more innovative sub-options, we have made reasonable estimates based on the best information available to us. As our innovation trials progress, we will update the assumptions for our PR19 business planning.

7.21 Societal valuation

In order to inform our cost benefit analysis, we have undertaken extensive work to understand the value that customers place on certain standards of service and different outcomes.

The overall methodology and approach for delivery of societal valuations required for the WRMP and PR19 business planning has been underpinned by the development of a valuation strategy.⁴⁰ We developed this strategy by prioritising the values required for business planning (including WRMP) by assessing them against the four criteria listed below:

- Customer priority
- Stakeholder importance
- Size of investment programme, and
- Sensitivity to cost benefit analysis.

Water resource options, including leakage and demand management, were assessed as being a high priority.

As a result, the PR19 societal valuation programme looked to ensure there were a range of valuation studies and valuation methods that could inform this process for water resource options including:

- A Main survey: a stated preference study covering a broad range of service attributes across the business including leakage reduction and water restrictions.
- A Second stage water resources study: focusing on customer preferences and valuations for water resource options and water restrictions.

The second stage resilience study utilised a stated preference approach, which is a survey-based method for eliciting customer priorities and preferences for changes in service levels. A total of 1,008 household customers and 408 non-household customers were interviewed with the survey administered through online interviews. The two samples are representative of their respective customer bases. The study was undertaken in line with latest best practice guidance.

Customer values for water resource options

This second stage resilience study elicited customer preferences for a range of water resource options:

- Demand management options: leakage reduction, incentives and education to save water, providing water saving devices, compulsory metering, encouraging metering.

The survey also asked customers to value the benefits of the introduction of smart meters. These benefits result from the abundance of frequently read consumption data that they provide, enabling customers to manage their consumption more effectively, thus saving water and money. In addition, smart meters should also help in identifying potential leaks.

Given the complexity associated with these areas, we placed a large focus on ensuring our surveys were accessible and meaningful. This included a comprehensive design and testing phase, a focus on ensuring the survey was engaging to customers to promote understanding and considered responses, and undertaking detailed analysis and validity testing of the results. To add further assurance and deepen our understanding of the results, we followed up the surveys with customer focus groups that discussed the results and checked our interpretation of them.

⁴⁰ Informed by work undertaken by NERA for Anglian Water on "Developing a PR19 Valuation Strategy", February 2017.

Societal valuation - smart meters

For smart metering, we have evaluated the value that customers place on having a smart meter. Smart meters can also help us and our customers identify leaks. To account for this, we have apportioned some of the monetised benefit from the customer valuation for fixing leaks to the AMI business case. This has been done on a pro-rata basis for both reduced CSPL, which will be enabled by the smart metering system, and the reduction in distribution network losses attributable to smart metering. We have been careful to avoid double counting of these benefits within the leakage business cases.

7.22 Using the societal valuations

The results from the PR19 second stage water resources study and the main stage study have been taken into account in providing recommended values for use in the WRMP and demand management strategy cost-benefit appraisal. This reflects a process of triangulation which is the use of multiple, independent data sources and research methods to produce a common perspective or understanding. The key steps in the process include synthesising and assessing the evidence based on relevance and robustness. It also involves reviewing the recommended values in comparison to PR14 values and other company studies as well as in the context of the wider customer engagement evidence.

The triangulation resulted in a range of estimates for each category of intervention. The ranges are made up of low, middle and high estimates. We have undertaken our CBA using both the low and middle points of the societal valuations, in order to take a conservative approach to these benefits.

For ‘leakage reduction’, ‘providing water savings devices’ and ‘incentives and education to save water’, we have applied the values to the water saved in each of these categories under each of the options.

For smart metering, we have accounted for the value that customers place on having a smart meter. Additionally, smart meters can also help customers and ourselves to identify internal plumbing leaks, cspl and distribution losses.

To account for this, we have apportioned some of the monetised benefits from customer valuation for fixing leaks to the smart meter business case. This has been done on a pro-rata basis for both the reduction in customer supply pipe leakage (cspl), which is enabled fully by smart metering, and the reduction in distribution network losses attributable to smart metering. We have been careful to avoid double counting of these benefits within the leakage business cases.

As our main survey has continued to gather evidence from a range of sources, the values we have used has been modified to reflect this in our final plan.

7.23 Option 1 - Extended

Cost-benefit analysis

The Extended strategic option represents an ambitious extension of our demand management techniques. The figure below presents the aggregate results of our CBA for this strategic option.

Figure 7.8: Costs and benefits of the Extended strategic option (25 year incremental NPV) with mean societal valuation

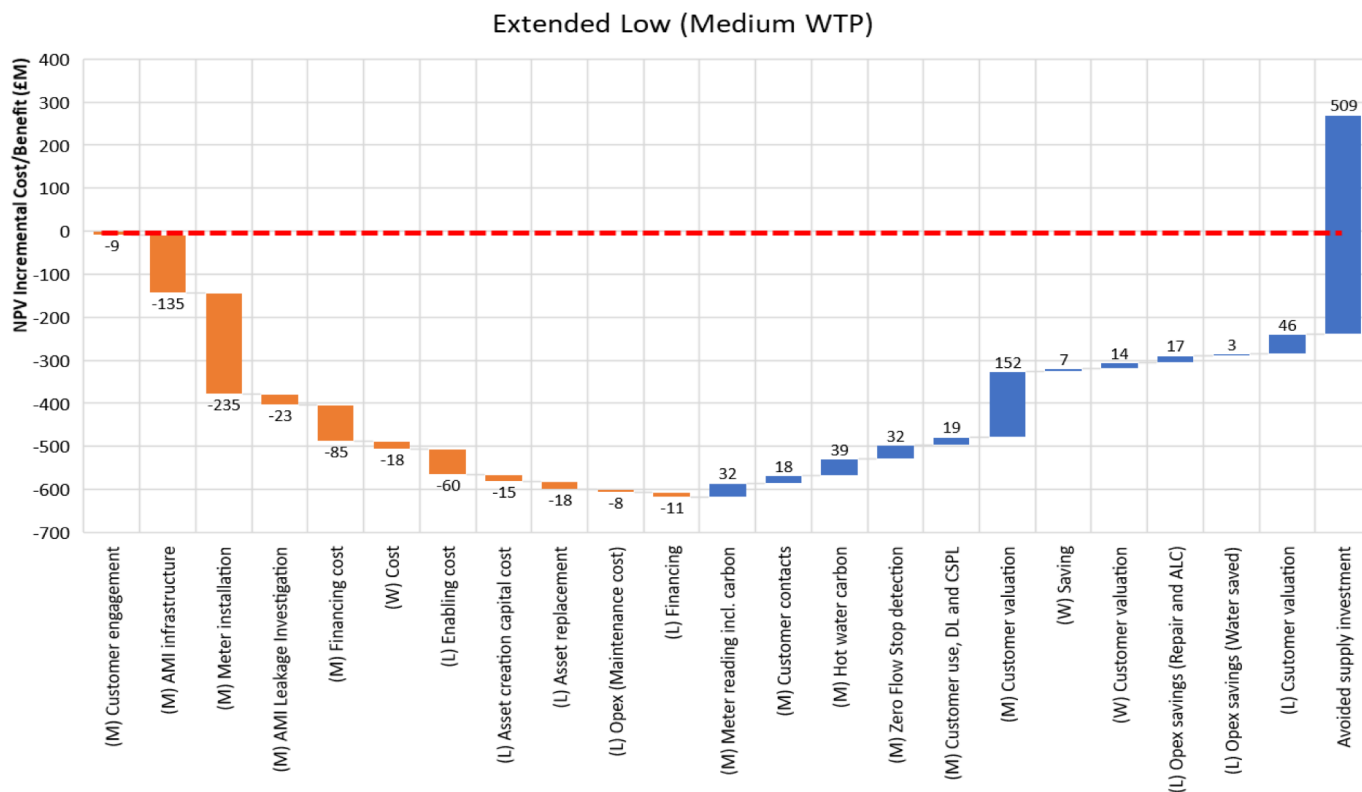

The CBA demonstrates that the overall economic benefits would be the least beneficial for this package.

Demand reduction (water savings)

The Figure shows our expected water savings from this strategic option.

While it is an extension of our current demand management activities, it would not, alone, be sufficient to mitigate expected demand growth. This means we would need additional supply side investment in comparison to the other strategic options.

Figure 7.9: Water savings for the 'Extended' option (Low option)

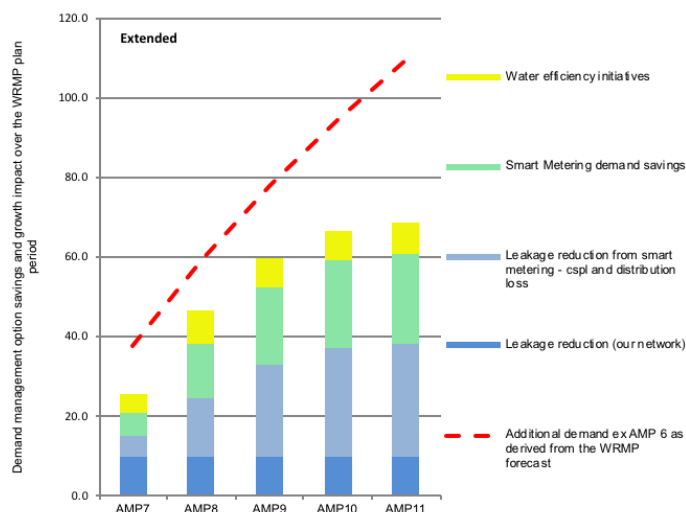

7.24 Option 2 - Extended Plus (preferred)

Cost-benefit analysis

The 'Extended Plus' strategic option represents an ambitious extension of our demand management techniques.

It builds on the Extended option with a faster smart meter roll-out and large scale piloting of innovative water efficiency programmes. The figure below presents the aggregate results of our CBA for this strategic opt.

Figure 7.10: Costs and benefits of the Extended Plus option (25 year incremental NPV) with mean societal valuation

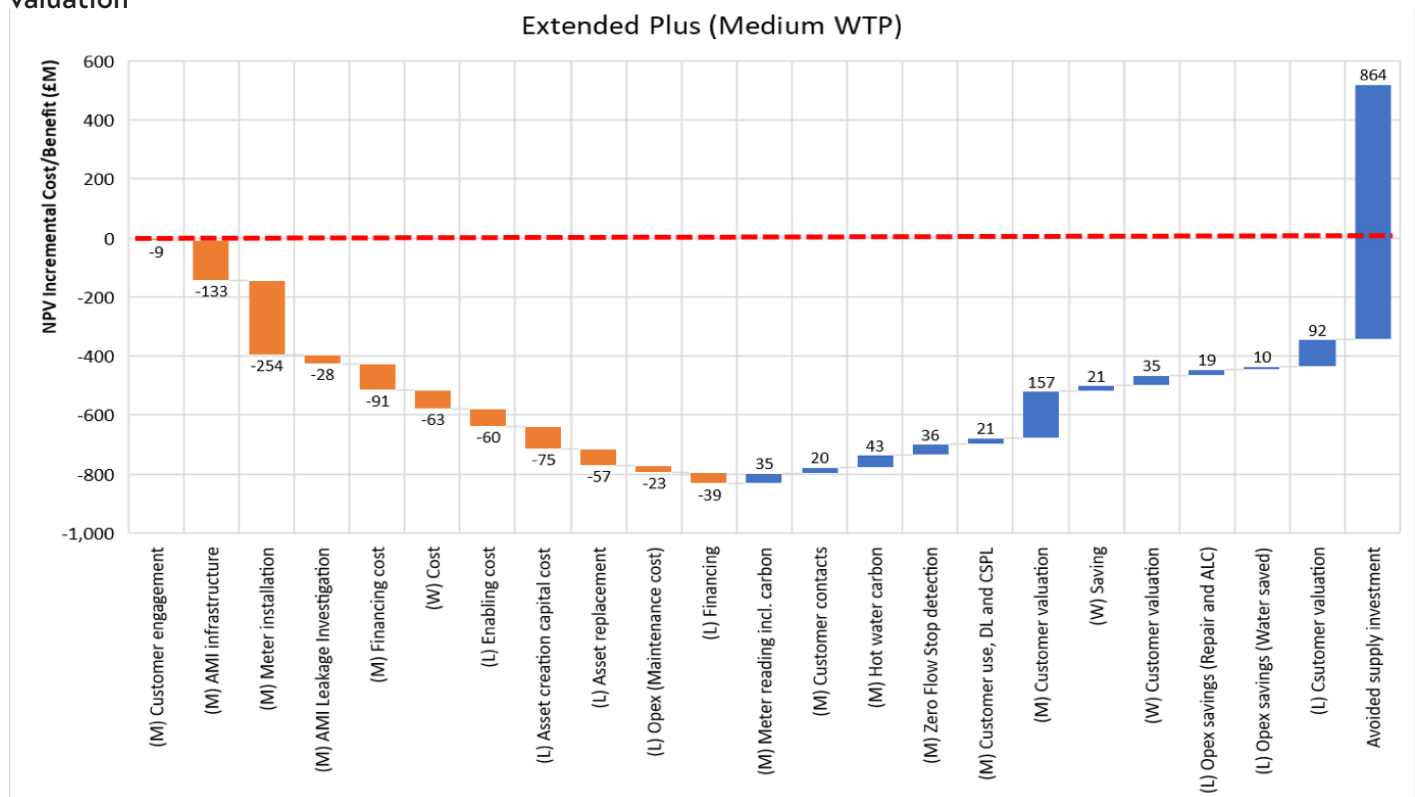

Our CBA shows that there is a strong business case for this option. This is the most cost beneficial of the three strategic options.

With regard to this option we have undertaken a programme of sensitivity analysis, testing the following scenarios:

- Increased costs of capital expenditure by 10% (capex) and increase costs of Operating expenditure of 5% (Opex)
- Using the lower estimate of the societal valuation results (our main CBA used the central estimate)
- Using lower than expected consumption reductions (water savings) of either 15% or 30%, and
- A combination of the higher cost and lower consumption reduction scenarios (15%) while using the low estimate of societal valuation.

The 'Extended Plus' option remains cost beneficial in all of these scenarios, even in the combined scenario. It is worth noting that the Extended and Aspirational options were not cost beneficial in the combined stress-testing scenario.

Figure 7.11 Sensitivity analysis for costs and benefits of the total Extended Plus option package (25- year incremental NPV) with lower value customer valuation, increased costs and reduced water savings by 15%

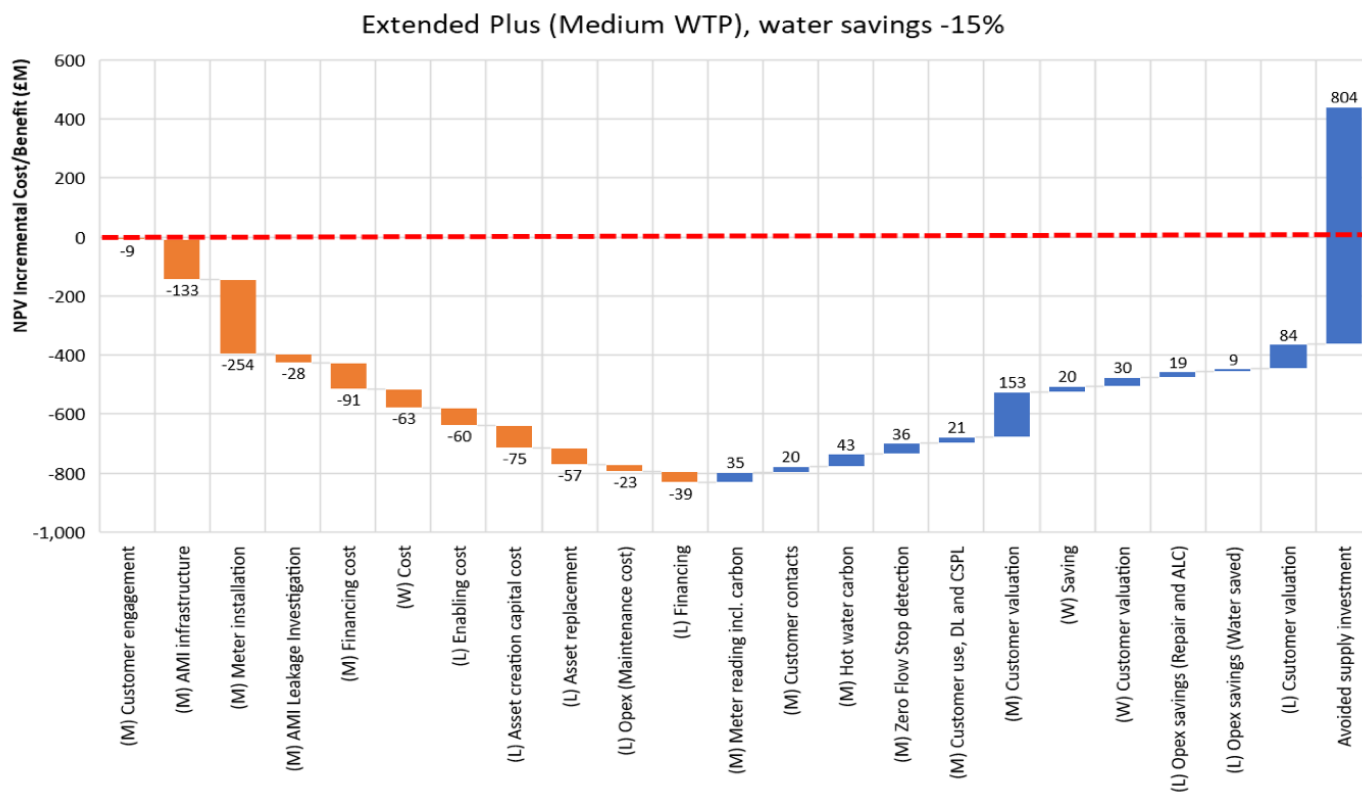

Demand reductions (water savings)

The figure below shows our expected water savings from this strategic option. The 'Extended Plus' strategic option builds on the 'Extended' option with a faster smart meter roll-out and large scale piloting of innovative water efficiency programmes.

This option would be sufficient to account for expected demand growth, avoiding some of the supply side investment needed under the 'Extended' option and delivering environmental benefits.

Figure 7.12: Water savings for the 'Extended Plus' preferred option

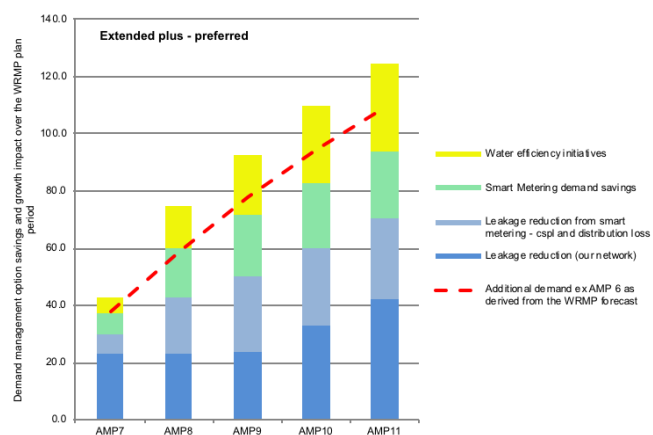

7.25 Option 3 - Aspirational

Cost-benefit analysis

The Aspirational strategic option builds on the previous options with a faster smart meter roll-out than the Extended option and a large scale roll-out of additional innovative water efficiency programmes. The figure below presents the aggregate results of our CBA for this strategic option.

Figure 7.13: Sensitivity analysis for costs and benefits of the Aspirational option (25-year incremental NPV mean societal valuation)

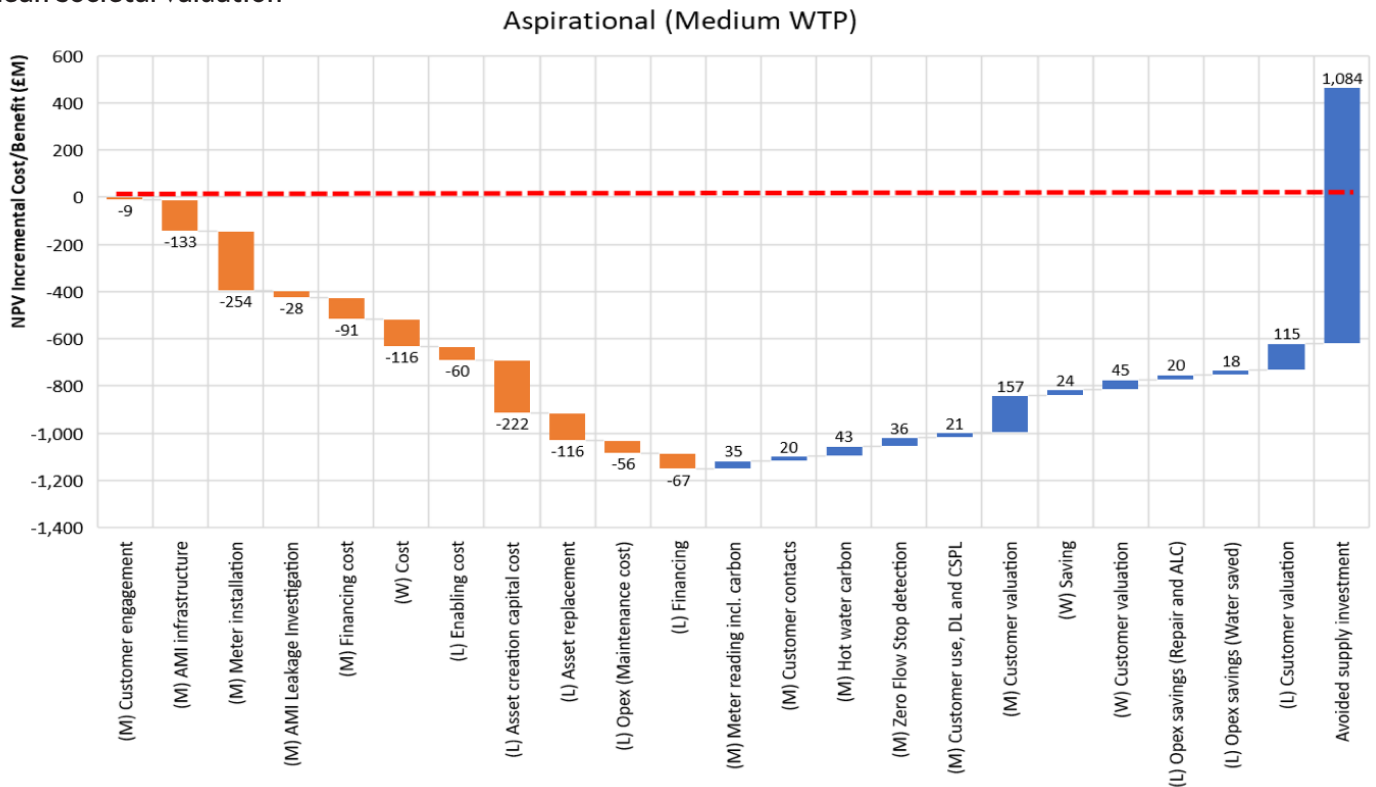

Our CBA shows that there is a positive business case for this option, although it is not as strongly cost beneficial as the 'Extended Plus' option. Due to the more innovative nature of the sub-options there is much more uncertainty around the delivery of net benefits than under the more conservative Extended Plus option. Within the option, the leakage, metering and water efficiency business cases are cost beneficial on a stand alone basis.

Demand reductions (water savings)

The figure shows our expected water savings from this strategic option. This option delivers the highest levels of demand reduction, albeit with the greatest level of uncertainty. If the expected savings were delivered they would be more than sufficient to account for expected demand growth.

If achievable, this strategic option would offset many of the supply side options.

Figure 7.14: Water savings for the 'Aspirational' option

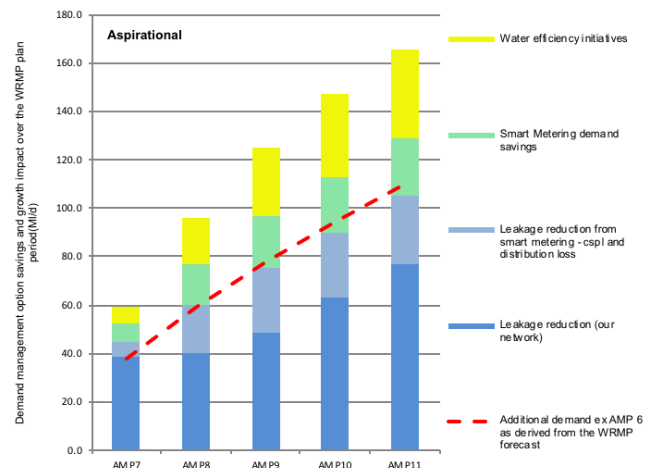

8. Risks and issues

Whilst developing our programme for future demand management, we have been keenly aware of the risks associated with implementing such an ambitious strategy.

We have, consequently, considered these risks, as an integral part of planning the demand management programme.

These risks will be differentiated with regard to each element of the strategy, but might be characterised as being associated with the following issues:

- Not achieving the demand savings that are anticipated in the plan for smart metering, leakage and our water efficiency programme.
- Issues associated with the scale of the roll-out of the smart meter network, and reaching our goal of full meter penetration (installing 2 million meters over 10 years).
- Deployment of new and innovative technologies, for leakage reduction, smart metering and water efficiency programmes could prove problematic and challenging.
- Correctly targeting the demand options to address WRZ supply-demand balance issues.

Risk Mitigation

These risk will be mitigated by setting up clear monitoring programmes and adopting Adaptive Planning Strategies.

- Risks will be mitigated by ensuring AMP7 targets are relatively conservative, allowing for continuous review processes and for the potential for 'out-performance'.
- Metrics will be designed to allow continuous monitoring of the progress of installation and roll-out programmes, customer engagement and with respect to all the benefits we have identified and expect including demand savings..
- Trigger points and 'signposts' (leading up to WRMP24) will be defined, as the demand management strategies are implemented, to track performance and indicate whether additional supply side options might be required or whether additional demand options should be considered.

8.1 Anticipated risks and issues

Throughout our planning process we have been keen to try and understand and anticipate any issues that might arise, as we aim to reach our ambitious goals for reducing demand and engaging, in new and innovative ways, with our customers.

As part of our planning process we have conducted an extensive analysis of the option packages to determine the 'best value' package of demand management options which might meet our ambitious target.

As discussed, there are significant synergies between leakage reduction, smart metering and water efficiency activities and it is essential to consider demand management programmes holistically through the development of strategic options. Each strategic option includes smart metering, leakage reduction and water efficiency activities, and has been built from the bottom-up by combining option designed at the WRZ geographic level.

Double counting

We have diligently accounted for inter-dependencies when estimating water savings and undertaking our cost-benefit analysis. In particular, we have been careful to avoid any double counting of reduced distribution losses between the leakage and smart metering programmes. Both sets of assumptions have been developed in parallel to ensure they are complimentary, but do not overlap.

We have also carefully considered the delivery risks associated with each demand management sub-option. As the demand management options differ in nature from supply options, so do the relevant risks.

For demand management, risk can be spread across the strategic options. For example, one meter installation may take longer than another but the majority may be quicker than expected. In this way we have built assumptions regarding risk into our analysis.

For many of our options, the approaches we will adopt are similar to those we have used previously (even if the technologies are different). We have undertaken extensive meter installation activities in recent years, including smart meter trials and now have a high penetration of meters. As such we have a good understanding of the relevant risks and constraints of installing meters.

Smart metering, new technologies and delivery

For newer techniques we have used our 'Innovation Shop Window' in Newmarket to test new technologies to help us understand their efficacy, possible risks and mitigations.

However, we understand that the risks associated with the deployment of new technologies (the network, mobile applications etc.) will need close monitoring as they progress.

As part of our procurement process we have identified that the smart meter network and data transmission will be key to our smart strategy.

Consequently, the current option is based upon the 'least risk' network solution, offered by a proven supplier. The collection of accurate and timely smart meter data, will be fundamental to our success, especially at the inception of the programme, when customers are first being engaged, and confidence in the system is being built.

However, we will continue to evaluate alternate lower cost offerings, during the procurement process, whilst understanding the potentially increased risks they pose.

We will also continue to investigate where efficiencies can be built into the smart meter plan, although it is noted that the over-riding cost associated with the programme will be the construction of the data transmission network.

We have accounted for likely constraints within our strategic packages. For example, our experience with metering to date suggests that the highest penetration of meters we are likely to achieve is around 95%. To achieve higher penetration of metering involves costs that are disproportionate to the likely benefits. As such our smart metering options assume we will only achieve up to 95% penetration.

We understand that there are risks associated with our current understanding of the deployment of smart metering, including the full costs of implementation (especially with regard to the network); potential water savings and observed decay rates associated with those savings.

However, we have based our current plan on the 'best' available data, and our experiences from Newmarket, Norwich and Colchester.

Plans for resourcing the processes required to scale up from our smart meter trials, to the full Anglian Water region, are currently being developed.

Finally, we have been relatively conservative (based upon data from the Newmarket trial) in our estimates of savings, which might be expected, mitigating some of the risk associated with extending our programme beyond the confines of our trial areas to the whole of the Anglian Water region.

Behavioural change risks

In addition to delivery risks, there are wider risks to achieving the estimated water savings for demand management. These are the risks associated with customer behaviour. Many of the options are dependent upon our customers taking action, e.g. changing their behaviour or installing a device. If customers do not act as we expect, this will impact the water savings.

- We have built relevant decay rates into the assumptions about water savings.
- Our assumptions regarding water savings are designed to be ambitious, but still achievable. Where possible and appropriate, they are informed by our own historic experience, internationally referenced data, other water company experience, and our own trials such as Newmarket Shop Window.
- Allowances have been made for leakage uncertainties (including cspl and plumbing losses) in the development of our Target headroom assessment.

We are conscious that customer behaviours can be hard to predict. We are also conscious that developing and maintaining customer engagement, will be key to customer satisfaction and achieving the demand reduction goals we have set.

We will, therefore, be keen to ensure that the design and presentation of information to our customers (via the web-portal and mobile applications), should be clear and keep customers engaged.

We also understand that the scale of customer contact which will potentially be driven by the step change in our engagement (via the web-portal and mobile application), will need careful management.

These processes will require continuous monitoring, validation and update as the smart meter roll-out proceeds.

Leakage reduction

Risks have also been highlighted with regard to setting our ambitious target for leakage, beyond the currently agreed WRMP14 baseline of 177MI/d (3 year rolling average).

Achieving the 30 MI/d leakage reduction will be challenging and represents a significant increase on the target we set for AMP6.

Achieving this will depend largely on our ability to upscale our intensive leakage investigation and solution delivery processes.

There are also risks associated with the weather, as both consumption and leakage are influenced by prevailing weather conditions.

We have, consequently, accounted for some of this uncertainty using our Target Headroom assessment.

8.2 Scenario testing

We additionally tested scenarios, in which the demand management strategy was modelled to under-achieve in terms of savings, in order to determine the implications for the supply-demand balance and potential supply-side options (or additional demand management option modifications) that might be required in this event.

Specific scenarios, were modelled to include demand management options that would save 15% and 30% less water than expected in our Extended Plus (preferred option)

The savings for our strategic options (low - 'Extended'), (medium - 'Extended plus' (preferred)), (high - 'aspirational') and the minus 15%, minus 30% 'Extended Plus' savings scenarios, can be shown.

Figure 8.1: Comparison of savings for Extended, Extended Plus and Aspiration Options (including sensitivity testing of Extended Plus with reduced savings (-15% -30%) option

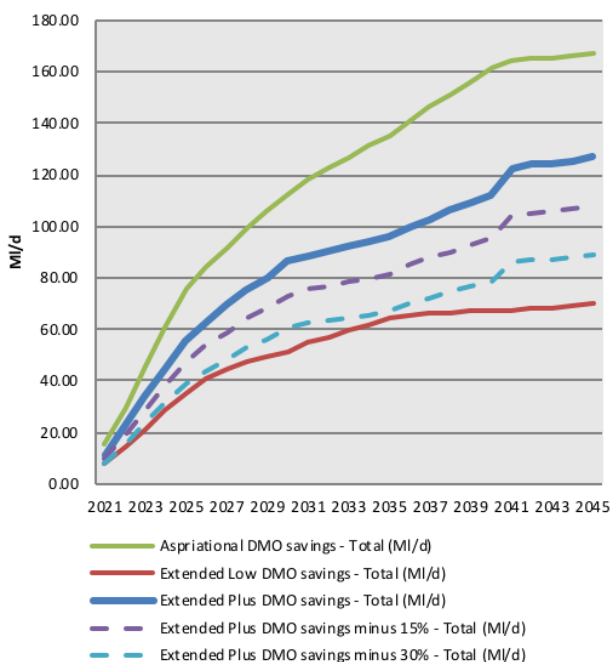

The differences in water saved can also be shown when compared to our preferred 'extended plus' option, showing that if the extended plus programme, achieved a 15% less savings, this would be equivalent to a reduction in savings of -8MI/d compared to the anticipated amount and 30% savings would incur a reduction of -16MI/d compared to the anticipated value.

It is noted that overall, the impact of somewhat reduced demand management savings (-15%) on the Supply-Demand balance will be relatively modest in AMP7, allowing for correction going forward.

Additionally, it is noted that the minus 15% and minus 30% scenarios lie within a range between our 'Extended' and 'Extended Plus' Options

Table 8.1: Difference between scenarios and the preferred option (Extended Plus)

	End AMP7	End AMP11
Extended Low DMO savings - 'difference to Ext Plus' (MI/d)	-20.37	-56.92
Extended Plus DMO savings - 'difference to Ext Plus' (MI/d)	0.00	0.00
Extended Plus DMO savings minus 15% - 'difference to Ext Plus' (MI/d)	-8.35	-19.01
Extended Plus DMO savings minus 30% - 'difference to Ext Plus' (MI/d)	-16.71	-38.02
Aspirational DMO savings - 'difference to Ext Plus' (MI/d)	19.89	40.59

Table 8.2: Total saving for each option and reduced saving scenarios

	End AMP7	End AMP11
Extended Low DMO savings - Total (MI/d)	35.32	69.81
Extended Plus DMO savings - Total (MI/d)	55.69	126.72
Extended Plus DMO savings minus 15% - Total (MI/d)	47.34	107.72
Extended Plus DMO savings minus 30% - Total (MI/d)	38.98	88.71
Aspirational DMO savings - Total (MI/d)	75.58	167.31

Consequently, per capita consumption (for each strategic option and for the Extended Plus sensitivity tests) shows that for the Extended Plus option, even with reduced demand savings, the PCC values remain within the 120-125 litres/head/day range.

Figure 8.2: Comparison of Per Capita Consumption for Extended, Extended Plus and Aspiration Options (including sensitivity testing of Extended Plus with reduced savings (-15% -30%))

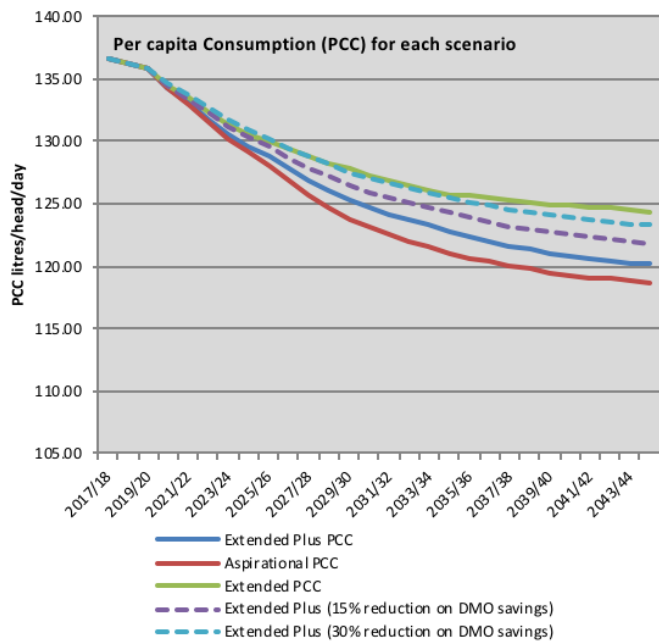

Note that in addition to the sensitivity testing carried out for the Extended Plus Option, similar scenarios with demand management reduction (minus 15% and minus 30%) have been created and tested for the Extended and Aspirational strategic options.

8.3 Monitoring programmes, 'trigger points' and adaptive planning

We also plan to develop monitoring systems for all aspects of the demand management strategy roll-out, such that;

- We monitor the operational roll-out of the programmes for the smart metering, leakage and water efficiency measures, ensuring we meet our targets for installation and customer engagement,
- We monitor all aspects of the expected customer benefits and ensure customer satisfaction with the new, innovative processes being introduced,
- We monitor and assess how the new processes can be effectively deployed internally, ensuring that synergies are identified and processes improved,

- We monitor the demand reductions and water savings that are generated by the implementation of the programmes.

We will ensure that, as the programmes are developed, we are able to adapt to additional information as it arises.

This will involve definition of meaningful metrics and the setting of specific 'trigger' points which will cause meditative action to be taken.

8.4 Risk mitigation

Risk will be mitigated by setting up clear, continuous monitoring strategies and adopting 'Adaptive Planning Strategies' dependent upon the outcomes:

- Risks will be mitigated by proposing relatively conservative AMP7 targets with continuous review processes.
- Meaningful metrics will be identified for all aspects of the demand management strategy and programmes, in order to ensure that we meet our targets for technical roll-out, customer engagement and the benefits we have identified and expect to see.
- Trigger points and 'signposts' (WRMP24) will be defined as the demand management strategies are implemented to track performance and indicate whether additional Supply side options will be required or whether additional demand options should be considered.

Figure 8.3: Example programme timeline, with 'trigger' points

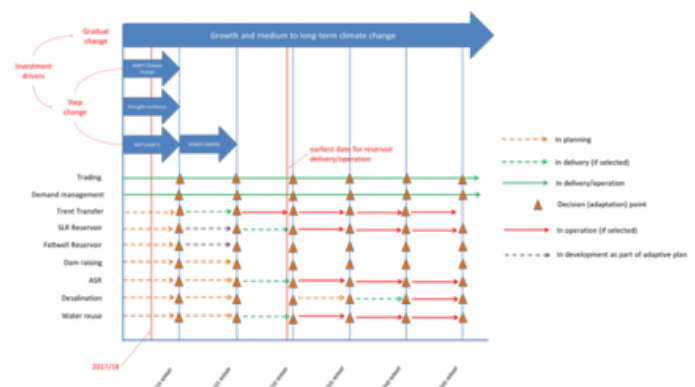

8.5 Smart metering and wider UK experience

We are aware of Parliamentary concerns regarding the current programme for smart metering across the UK for the energy sector.

The British Infrastructure Group of Parliamentarians (BIG) has recently produced a report 'A comprehensive investigation into the roll-out of energy smart meters' (41) detailing issues that have been identified, as this major alteration to UK infrastructure has progressed. The planned roll-out

involves installing 53m energy smart meters to 30m homes and small businesses by 2020.

Key issues for the energy sector smart meter programmes have been identified, however, as noted, many of these issues have already been considered in our 'smart water meter' preferred planning scenario.

Table 8.3: Issues identified by BIG regarding the energy sector smart meter programme

	Energy Sector Smart Meter Issues	Our Smart meter Preferred Plan
Technological	'Obsolete meters (2012 design, with limited functionality) are still being rolled-out, and new generation smart meters have been delayed.' ⁴²	Smart meters will be installed using the most currently available technologies. These will be constantly be reviewed during the 10 year roll-out process. The roll-out programme has been geographically designed to enable the installation of 'anticipated' new technologies, whilst not leaving 'stranded assets'.
Technological	'Smart meters 'go dumb' after switching (noting the retail market in the energy sector for household customers): (Of the 1m customers with a smart meter who annually switch provider, over half are left with a meter which has lost its smart features).' ⁴³	Currently the domestic water sector is not subject to retail market conditions, however, under our current plan it is envisaged that data would be easily transferable, if this situation changed.
Technological	'Energy meters are reliant on existing mobile networks to send data, and accordingly do not work in areas with poor signals, and so again revert to 'dumb' mode.'	The preferred smart meter plan utilises a bespoke network, for data transmission, not local WiFi, and as such, should not be subject to localised data transmission issues. Data transmission will be constantly monitored and data redundancy has been built into the current 'meter read' system.
Commercial	'Working smart meters being needlessly replaced: Commercial agreements mean that new suppliers will often replace an existing smart meter, even when they can receive data from it.'	This will not currently have direct implications for the household water sector, as retail split for household water customers, has not been enacted. The programme will include the replacement of some 'dumb' meters before the end of the normal replacement cycle, but the benefits have been calculated to outweigh this cost.

⁴¹ A British Infrastructure Group (BIG) Report: Not so smart: A comprehensive investigation into the roll-out of energy smart meters

⁴² BEIS, 'Written Question - 125235', 01 February 2018.

⁴³ BEIS, 'Maximising interoperability for first generation (SMETS1) smart meters', 17 April, 2018, Page 5.

	Energy Sector Smart Meter Issues	Our Smart meter Preferred Plan
Commercial	'Roll-out is already behind schedule and the 2020 (energy sector) target is likely to be missed: As only 11.06m smart meters were operational by the end of Q1 2018, suppliers have under 3 years to offer and potentially install up to 41m more of them. ⁴⁴ This equates to almost 1.3 million meters a month. By April 2018, large suppliers were though only managing to install around 420,000 each month.' ⁴⁵	It is noted that, although ambitious, the smart meter roll-out, is of a smaller scale to the UK wide energy smart meter roll-out. Average smart meter installations will be in the order of 150,000 per year in AMP7 (12,500 per month). Additionally it is noted that the majority of our meters will be external and easily accessible by our operatives.
Economic	'Initial savings in customer energy bills have more than halved ⁴⁶ and Predicted savings are inflated.	We will ensure rigorous monitoring of both the progress of the smart meter installation roll-out and demand reductions. Additionally, we have tried to be conservative in our assessment of water savings and as seen in the Newmarket trial, current indications are that savings should exceed those accounted for in the preferred plan. We are, however, aware of the potential implications of scaling up the programme, in terms of wider geographies and customer inertia.
Economic	Roll-out costs continuing to increase.	Normal procurement procedures will be followed to ensure that we achieve the best value for both the fixed network and smart meters, and costs will be continuously monitored through the roll-out programme.
Regulatory	No unified data control point: There is no single unified way for consumers to check who is accessing their energy data, when and why they did so, and to stop that access.	We are planning to ensure that all customer data is protected, encrypted and meets GDPR standards. We have also given consideration with regard to how we might treat customer information for those who might not wish to be part of the smart meter programme.

Despite these concerns it is, however noted that the BIG parliamentary group 'fully supports the rationale behind the energy smart meter roll-out, and the goals it seeks to achieve.'⁴⁷

We will, consequently, monitor the experience of other UK and overseas utilities with respect the their smart metering programmes, whilst noting the significant differences in our metering stock and data transmission requirements.

⁴⁴ BEIS, 'Smart Meters Statistics: Quarterly Report to end March 2018,' 31 May 2018.

⁴⁵ BEIS, 'Smart Meters Statistics: Quarter 1 2018', 31 May 2018, Tables 1a and 3a.

⁴⁶ Programme net benefits were predicted as £7.3bn in 2011, and £5.75bn in 2016, see: DECC and Ofgem, 'Smart Metering Implementation Programme: Response to Prospectus Consultation', March 2011, p5. and, BEIS, 'Smart Meter Roll-out Cost-Benefit Analysis: Part I', August 2016, Page 3.

⁴⁷ A British Infrastructure Group (BIG) Report: Not so smart: A comprehensive investigation into the roll-out of energy smart meters, Page 32

Appendix 1: Appraisal of Environmental and Social Impacts



Introduction

Water resource options have various associated impacts, or costs and benefits. Environmental and social impacts refer to the costs and benefits that are experienced by the environment and society, rather than by us and our customers directly.

For example, a sympathetically designed new reservoir could provide important new habitats and increase regional biodiversity, and it could also create new recreational opportunities. However, the reservoir would result in increased carbon emissions, particularly during the construction phase. Understanding these impacts helps us to ensure our plans are sustainable and provide best value to society.

Assessing environmental and social impacts is complex. Water resources options can impact upon the environment and society in multiple ways and certain combinations of options can produce additional cumulative effects.

Environmental and social impact appraisals can include qualitative, quantitative and monetised assessments. Once appraisals have been completed, we need to integrate the outputs into our decision-making process, ensuring that there is no double counting.

Our appraisal of environmental and social impacts was informed by the following assessments and reports:

- SEA (informed by the Habitats Regulations Assessment (HRA), WFD assessment and Invasive Non-Native Species (INNS) assessment); and
- Ecosystem Services Assessment (voluntary)

The SEA has been published on Huddle and on our company website. The Ecosystem Services Assessment is available on request.

This appendix sets out our approach to appraising environmental and social impacts. Note that there is a strong link to our customer engagement

programme, where we have explored the impacts of options extensively with our customers. Please refer to the supporting Customer and Stakeholder Engagement technical document for more details.

Our approach

Our draft Problem Characterisation assessment highlighted that our dWRMP would require trade-offs between costs and non-monetised 'best value' considerations, particularly in relation to:

- The scale of the demand management programme
- Identifying an appropriate Level of Service, and,
- The selection of supply-side options.

We concluded that a comprehensive appraisal of environmental and social impacts would be particularly important to the development of our WRMP, and we developed our appraisal approach accordingly. Our approach is in line with the WRP Guidance, Defra's Guiding Principles and the UKWIR SEA guidance.¹

We have undertaken a thorough assessment of Environmental and Social impacts followed the 'building blocks' approach proposed in the WRP Guidance². The SEA (informed by the Habitats Regulations Assessment (HRA), WFD assessment and Invasive Non-Native Species (INNS) assessment) provided qualitative and semi-quantitative assessments of the environmental and social effects at a detailed level, as set out in Figure 1.

¹ UKWIR, 2012, *Strategic Environmental Assessment and Habitats Regulations Assessment - Guidance for Water Resources Management Plans and Drought Plans*

² Environment Agency, Nov 2017, *Environmental Valuation in Water Resources Planning - Additional Information*

Figure 1: Strategic Environmental Assessment

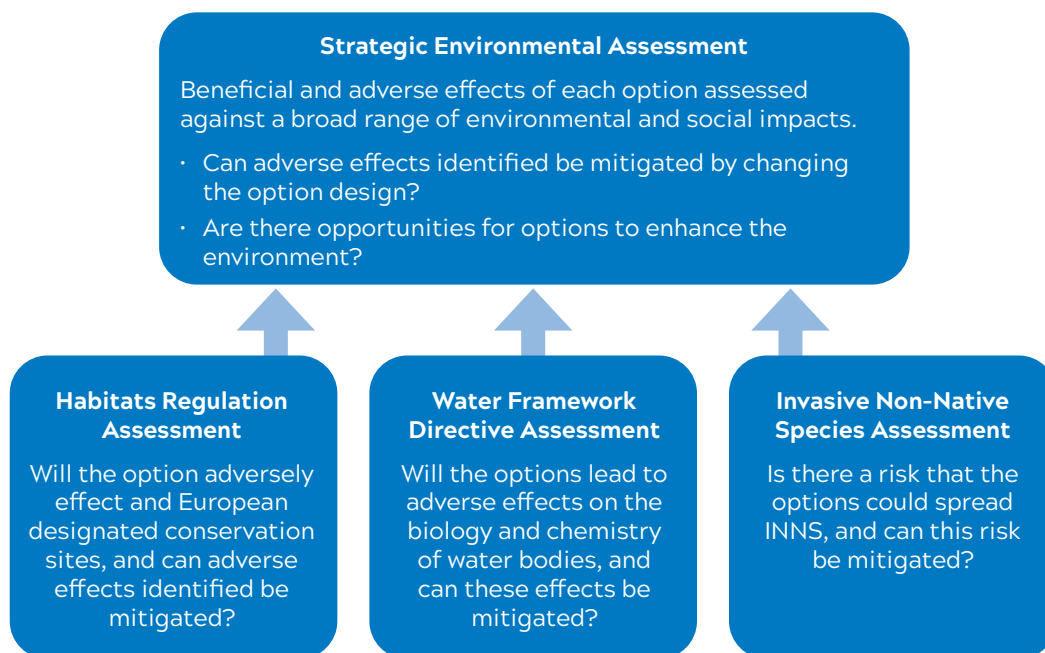

The assessment approach covered all stages of the development of WRMP, commencing with the 'coarse' screening of a very broad 'unconstrained' list of options, through to a 'fine' screening process, and the final constrained list of options, and assessment of alternative programmes and the plan as a whole (Figure 2). We also assessed the cumulative effects between different environmental and social aspects of a particular programme or plan, as well as between the alternative options and programmes.

Figure 2: Development of supply-side options

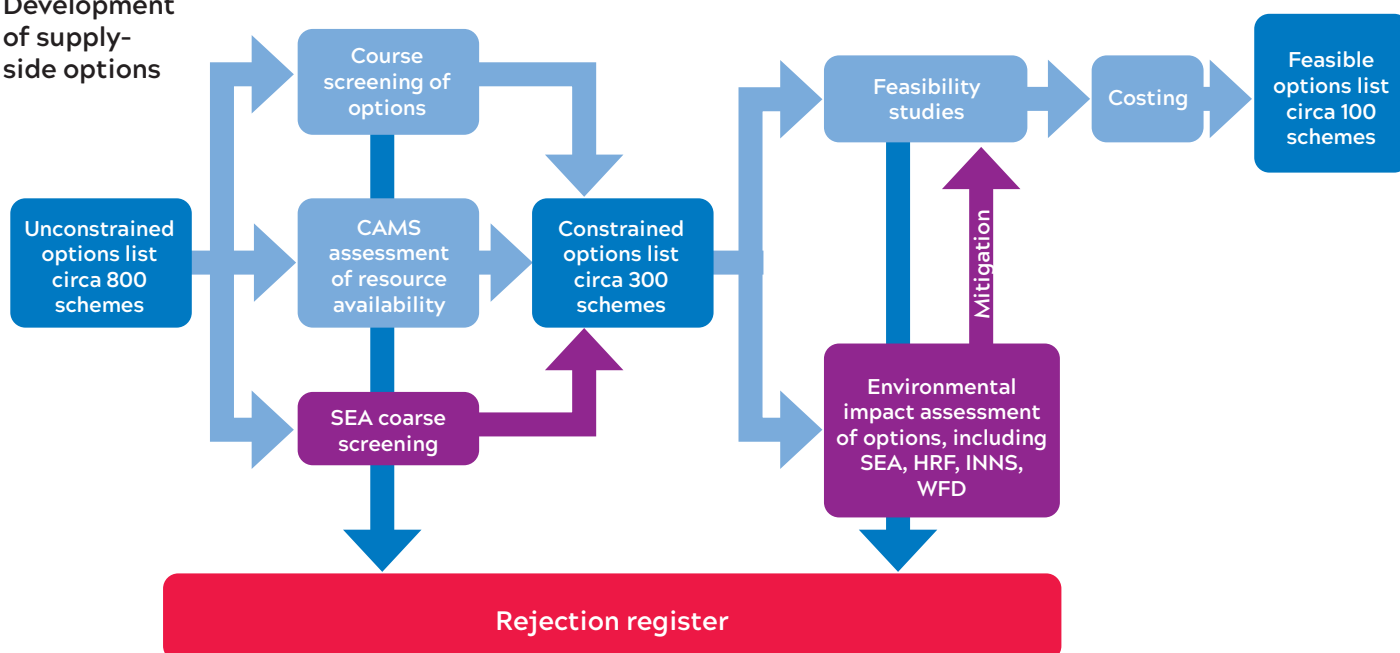

³CAMS = Catchment Abstraction Management Strategy

We have also voluntarily undertaken a qualitative Ecosystems Service Assessment (ESA) to complement the SEA and reflect the ambition expressed in Defra's Guiding Principles and the WRP Guidance to use natural capital and ecosystems services approaches.

Ecosystem services are defined as the benefits provided by ecosystems that contribute to human well-being. A qualitative ecosystem services assessment considers the effects of development on natural capital, and its ability to provide ecosystem services. Our approach to Natural Capital is described in more detail at the end of this appendix.

We considered the use of environmental valuation (using a monetised Ecosystems Services Approach). However, the absence of an agreed methodology and a lack of data means that currently, only certain environmental and social effects can be costed, thereby leading to a partial assessment. We discussed this with the Environment Agency and Natural England⁴, and agreed that there would be little benefit to the decision-making process in calculating environmental and social costs for a partial set of effects. As such, our qualitative ESA assessment produced outcomes were used alongside the SEA and HRA in the multi-criteria assessment to determine the Preferred Plan.

The only exception to this approach was the consideration of carbon impacts, which were included through a quantified assessment as they are commonly monetised using well established techniques. These have been included in the AISC calculations and represent the only difference compared to the AIC values. We have described the emission of greenhouse gases as a result of the Preferred Plan in terms of Tonnes of CO₂ equivalent in Section 5.8 of the WRMP. Individual option carbon costs are provided in the updated WRP tables. We have provided the greenhouse gas emissions from our current water operations in chapter 1. We have used the traded central values of the December 2017 version of the BEIS tables.

Our Ecosystem Service Assessment also provides valuable learning to contribute to the development of our Natural Capital approach in future Water Resources Management Plans.

Mitigation and opportunities for environmental enhancement

We are committed to delivering the required mitigation for the options defined in the Preferred Plan. As far as possible, we have ensured that all options are costed to include the mitigation identified as necessary within the HRA. Where negative effects were identified in the options assessment, these have been mitigated through the options design process where practicable, by re-routing pipelines or using directional drilling under sensitive sites and rivers or investigated further through the HRA and WFD processes. The use of best practice construction methods will also be utilised to minimise any effects during the construction phase. Minor negative effects remain for one option (Felixstowe Desalination) due to the predicted moderate effects on WFD objectives. Where effects relating to greenhouse gas emissions were known, all options had minor negative effects apart from three options where major negative effects were identified. Use of renewable energy technologies could help to reduce these effects.

Some options have been flagged for more detailed costing if the option is selected to be taken forward or at the detailed project design stage. In some cases it has not been necessary to cost mitigation options (e.g. when the cost difference for the mitigation option has been assessed as negligible). See Appendix L of the SEA for further details.

We are committed to securing a net benefit to the environment when delivering the options wherever possible. Our supply-side options have been designed at a high level, but detailed design work has still to be completed. We have identified opportunities for environmental enhancement in both the SEA (Appendix C and F-J) and as part of our Ecosystem Services Assessment. Our Natural Capital strategy which is currently being developed will also contribute to this.

⁴ At a methods discussion meeting, held on 6th June 2017

Planning for improved WRMP decision-making through the Natural Capital approach

Although Natural Capital was not directly used in the current WRMP option selection process, we are developing an approach to integrate Natural Capital thinking within our future decision making.

In 2018 we worked with UEA to undertake a natural capital asset check for the Anglian Water region. We wanted to understand the state and extent of natural capital in our region, so that we could develop our own approach to natural capital decision-making and show how we are contributing to the protection of the region's natural assets.

Natural capital can be defined as the world's stocks of natural assets which include geology, soil, air, water and all living things. Crucially, these assets provide many benefits to society, called ecosystem services. For example soil is vital for food production and water is taken from the environment to supply customers. If natural capital declines in extent or condition then the services they provide may also decline.

The Anglian Water region represents approximately 22% of both the land area and coastline length of England. The asset check for the Anglian Water region showed that our region is vital for food production, having 43% of England's most important farmland. It also showed that our region has only 11% of England's most important biodiversity. Furthermore, a third of all water bodies without capacity for further abstraction are found in our region.

Land cover in the Anglian Water Combines Service Area

Indicator	Km ²	% of England Total
Broad Habitat Classes		
Mountains, Moorlands and Heath	23	0.4
Semi Natural Grasslands	54	1.5
Enclosed Farmland	24,217	25.5
Woodlands	969	12.1
Freshwaters	201	37.1
Urban	2,505	15.3
Coastal Margins	144	36.2
Marine	63	27.0

We have extended our natural capital work into our water resource planning by including an assessment of the impact of the portfolio of options on the ecosystem services that are provided by these broad habitats. This was undertaken by mapping these habitats and, for each ecosystem service, scoring the importance, direction and magnitude of change that results from the implementation of each option.

We are developing a six-capitals approach to decision-making. In AMP7, we will take account of natural capital alongside the other capitals (social, financial, manufactured, human and intellectual). This will improve decision-making and help us, where appropriate, select options that better protect the environment. We will be reporting our performance using a set of natural capital metrics, which will include a metric for water resources.



Cover photo shows Rutland Water

Rutland Water is a reservoir in Rutland, England, east of the county town, Oakham. It is filled by pumping from the River Nene and River Welland and provides water to the East Midlands. It is one of the largest artificial lakes in Europe.

Anglian Water Services Limited

Lancaster House
Lancaster Way
Ermine Business Park
Huntingdon
Cambridgeshire
PE29 6XU

www.anglianwater.co.uk